

# ISDN TK-System

Manual

AC 14 USB

Telephone

Internet connection

And much more



**AGFEO**  
einfach | perfekt | kommunizieren



# Table of Contents

- The new kind of operation
- Safety instructions
- Important information for using analog terminals

- Scope of delivery
- Assembly of the telecommunications system
- Terminal connections
- ISDN connection

- Basic functions - "Telephoning", "Answering calls" and "Transferring a call"

- Programming with a PC. The configuration program TK-Suite Set is part of the TK-Suite software package.
- Remote configuration by the dealer
- Programming with a telephone
- Multiple Subscriber Numbers (MSN)

- Software overview
- Program components TK-Suite
- Installing TK-Suite
- CTI computer-assisted telephone calls via TAPI
- System conditions

- Glossary
- When something goes wrong
- Action in the event of faults

- Declaration of Conformity

- Pictograms and keys
- The LEDs of the AC 14 USB

- Connecting a printer
- Connecting a power pack
- Commissioning

- Comfort functions of the telephone system in alphabetical order

- Ringing assignments (day, night, internal call forwarding service)
- Authorisations (external authorisation, external access, regional range, barred range)
- Types of terminals

- Set up USB connection
- Install driver software
- Uninstall driver software
- Connections to Internet or other network

- Ringing and tones
- Technical data

## Introduction I

## Set up S

## Operation O

## Programming P

## Communication through PC C

## Appendix A

## Key words K

# Safety Instructions

The telecommunications system is designed for connection to an ISDN base connection (DSS 1 – multiple connection).

You can connect all analog terminals to the analog subscriber accesses of the telecommunications system which you can also

- The telecommunications system meets the prescribed conformity and safety requirements.
- Pull the power pack out of the mains socket to switch off the telecommunications system before connecting the leads to the subscribers and to the ISDN network. Danger of lethal injury!
- Do not connect or disconnect the leads during a thunderstorm.



operate on the analog telecommunications network.

Any other use of the telecommunications system is contrary to the intended purpose and thus prohibited.

The telecommunications system has the General Connection Licence (AAE).

- Lay the leads so that no-one can step on or trip over them.
- Make sure that no liquids get inside the telecommunications system.
- No liability will be accepted for consequential damage such as costs for an accidentally maintained connection.
- The telecommunications system is out of order during a power cut. You cannot use the phone.

## Important information about using analog terminals

You can connect analog **terminals** such as normal telephones (a/b), answering machines, group 2 and 3 fax's and analog modems to the terminals of your telecommunications system.

The **dialling method** of the analog terminal may be dual-tone multi-frequency dialling (DTMF) or pulse dialling (PD). The terminal should be set to DTMF to make optimum use of all functions. The telecommunications system automatically recognises the respective dialling method.

If you have switched on the "External seizure spontaneous with internal" function for your telephone (as-delivered state), you can reach an internal subscriber by dialling the **#** key (hash) and the internal phone number (11, ..., 14). On telephones without a **#** key or which do not support this, e.g. telephones with the pulse dialling method, no internal dialling is possible. You can reach an external subscriber directly by dialling the external phone number.

Your telephone should have a **\*** key (asterisk key) for simple operation of the telecommunications system. You can press the numbers **9 9** instead of the **\*** key on telephones which have no **\*** key or do not support these functions.

Please observe the following instructions: Analog telephones with DTMF require a signal key (refer back key **R**) with flash for the "refer back inquiry".

In this operating manual, the operating steps listed are always for analog telephones with DTMF. You do not need to press a signal key for the refer back inquiry on analog telephones with PD.

The functions of an analog telephone (e.g. dialling repetition, short dialling) can also be used in connection with your telecommunications system. Please see the operating manual of the telephone concerned for operation of these functions.

Please pay attention to the acoustic signals of your telecommunications system during operation. You will hear the acknowledgement tone when you have successfully completed a \* procedure. Otherwise you will hear the error tone (busy tone).

On analog telephones with caller number displays, the telecommunications system transmits the phone number (CLIP function) providing the caller has sent it.

For **modem operation** (transmission speed up to 56600 bps, can be reduced if necessary to 33600 bps by transmission paths and lines) it is recommended to set the port to "External seizure spontaneous" with the PC configurator. Otherwise it is absolutely essential to configure the modem to blind dialling because most modems are unable to recognise the dialling tone of a telecommunications system. Blind dialling is set with the help of the X0 ... X4 parameters for modems which operate with the Hayes command set.









# Pictograms and Keys

Operation of every function of the telecommunications system is explained clearly

and comprehensibly by pictograms.





---

## Pictograms

	Acoustic call signal (tone call)		Make call
	Lift handset		Replace handset
	Enter phone numbers, code numbers (PIN)		Conference
	Tones audible in the handset, e.g. acknowledgement tone		Room monitoring by telephone

---

## Keys

	Refer back key (signal key, flash key) for referring back during a call		Asterisk key for starting certain functions ( * procedures)
	Number keys for entering phone numbers, e.g. "9" or letters "X" (Vanity dialling)		Hash key for internal dialling for spontaneous line seizure, terminating an input

## The LEDs of the AC 14 USB

### Green LED – The function LED

- lights steadily when the telecommunications system is in operation
- flashes slowly when a diversion to an external subscriber is set up through the telecommunications in the ISDN exchange.
- Flashes rapidly when an entry is available in the telecommunication system's call list (this indication has priority over a diversion)

### Red LED – The busy LED

- flashes slowly when a line (a B-channel) is busy
- lights steadily when both lines (both B-channels) are busy



# Set up

## Scope of delivery

- 1 ISDN telecommunications system
- 2 plugs and screws
- 2 screw terminals 4-pole
- 1 ISDN connecting cable
- 1 PC connecting cable
- 1 230 V power pack
- 1 operating manual
- 1 CD-ROM with TK-Suite

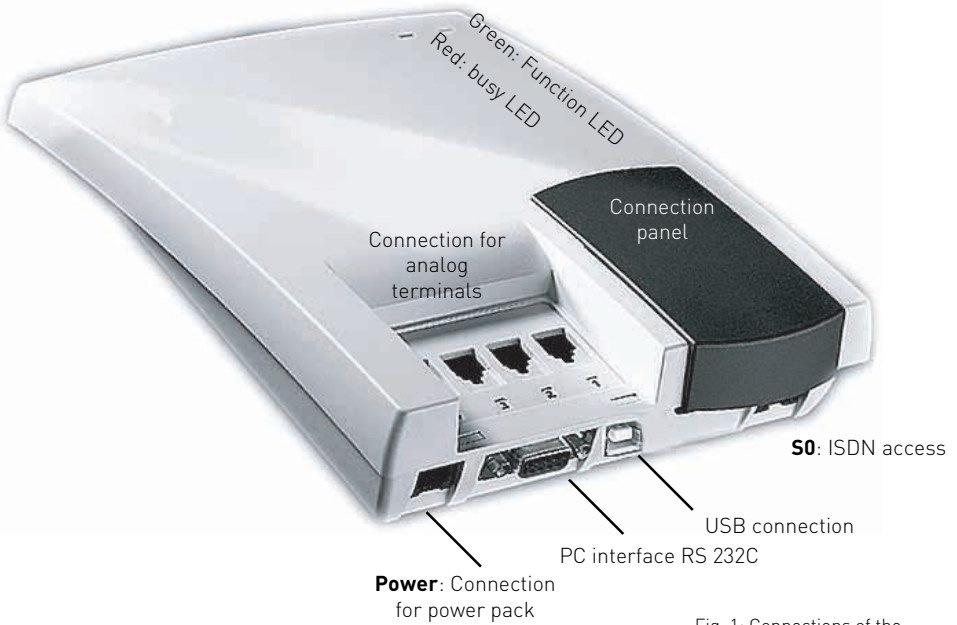

Fig. 1: Connections of the telecommunications system

## Choosing the location

The telecommunications system is suitable for operation on a desk top or for wall mounting.

Only install the telecommunications system in a dry room where there is no risk of explosions.

- Ambient temperature: 5°C to 40°C
- Humidity: max. 70 % (no condensation)

It may **not** be installed:

- in the vicinity of air conditioning systems, heaters
- where it may be exposed to direct sunlight
- in the vicinity of equipment with illegal interference radiation
- in an excessively dusty environment
- in places where it may be splashed by liquids

---

## 230 V mains power supply

The telecommunication system does not work when the 230 V mains voltage fails.

Only use the power pack model no.: TST 53328 provided.

---

## Connectable terminals

You can connect four analog terminals to the telecommunications system. You can connect all analog terminals which you can operate on the public telecommunications network.

Possible analog terminal types are:

- Telephones (a/b telephones)
- Fax machines group 3
- Answering machines
- Modems (up to 56600 bps, transmission can be reduced to 33600 bps if necessary by transmission paths and lines)

On analog telephones which display the caller number the TK-system shows the number (CLIP function) provided this is transmitted by the caller. For optimum use of all functions, the terminals

should set to dual-tone multi-frequency dialling (DTMF) and have a flash, \* and # key. The telecommunication system detects a flash time of 50 – 600 ms in its as-delivered state.

You can also connect terminals with pulse dialling (PD). The telecommunications system automatically recognises the dialling method. Dial a number greater than 1 on a terminal with PD after connection.

Please see the telephone documentation for switching the dialling method and setting the flash time of the telephones.

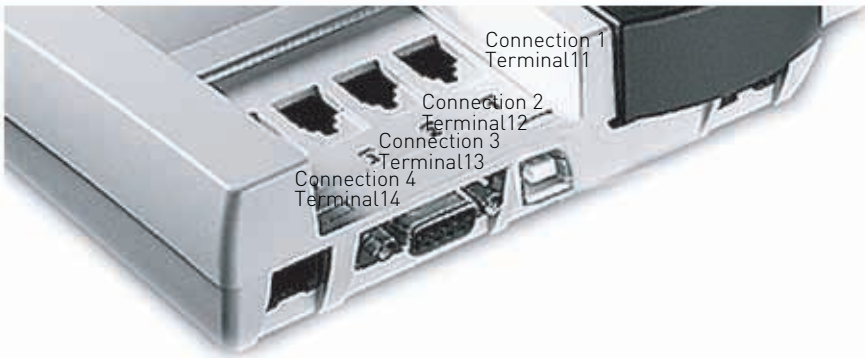

Fig. 2: Connection for terminals

---

## Notes on the ISDN access (S0)

The telecommunications system is designed for connecting to an ISDN basic access (multi-equipment access).

You can also operate other ISDN terminals at this access, e.g. your PC with ISDN card, an ISDN telephone and more.

The multi-equipment access may be designed as an ISDN bus which is connected to the NTBA. Up to 12 ISDN sockets (IAE or UAE) may belong to this bus. You can connect up to seven other ISDN terminals to the ISDN bus in addition to your ISDN telecommunications system.



## Wall mounting

- Mark two vertical drill holes 125 mm apart on the wall.
- When marking the drill holes, make sure that there are no concealed lines at these points (gas, water pipes, electric cables or similar).
- Drill the two holes.
- Mark two vertical drill holes 125 mm apart on the wall.
- When marking the drill holes, make sure that there are no concealed lines at these points (gas, water pipes, electric cables or similar).
- Drill the two holes.
- Hammer in the plugs flush with the wall.
- Screw in the two screws leaving the head protruding by about 4 mm.
- Hang the telecommunications system on the screws and pull it down on the wall until it snaps into place.

## Ready to start in seconds

- Plug the Western plug of the power pack into the socket marked "Power" until it snaps in audibly
- Plug one of the Western plugs of the ISDN connecting cable into the socket marked "SO" until it snaps in audibly
- Plug the other Western plug of the ISDN connecting cable into the NTBA (NT) or an installed ISDN socket
- Plug the Western plugs of your terminal into the Western sockets of the telecommunications system
- Plug the power pack into a 230 V socket. The green LED lights up.
- You can now use the phone. After lifting the handset you will hear the external dialling tone and can call any external subscriber.
- The internal phone numbers 11, 12 and 13 are called when one of your phone numbers (MSN) is called.

In the **as-delivered state**, the connections 1 and 2 are set to telephone, connection 3 to answering machine and connection 4 to combi-  
port, e.g. for fax.











To enter your multiple subscriber numbers (MSN's), change the ringing assignment and set other functions, please read the chapter "Programming".







## Quick entry of multiple subscriber numbers

You can enter multiple subscriber numbers (MSN's) under which you can be reached in the telecommunications system uncomplicatedly and quickly. Enter the MSN with this function at every connection and the corresponding terminal is entered in the ringing assignment for this MSN.

Example: Enter your phone number (345678) at connections 1, 2 and 3. At connection 4 the number of your fax (345677). Callers then reach your telephones and answering machine when they call 345678. The fax is reached under 345677. See the "Programming Instructions" for further information.

Start programming mode:      (system -PIN)    
**PRO**

										
Lift handset	<b>MSN quick save</b>					<b>MSN-ID</b>	Enter multiple subscriber number (MSN)	Acknowledgement tone	Replace handset	

Exit programming mode:         
**END**

---

## Connecting terminals to separate TAE sockets

If you want to connect your terminals to separate Western sockets, you will find the connection panel for the plug-in terminals underneath the blue cover.

Unplug the power pack from the 230 V mains socket before removing the cover from and working on the connection panel. Replace the cover before plugging the power pack back into the mains socket.

To open the connection panel, reach underneath the blue cover on the connection side of the telecommunications system and pull the cover down sharply.



The assignment of the terminal connections is displayed on the connection panel.

To ensure perfect functioning of the telecommunications system and the connected terminals, you should connect the terminals either to the Western sockets or the plug-in terminals! This means that if a terminal is connected directly via a Western socket, e.g. connection 1, no second device should be connected via the terminals at the same terminal connection, e.g. La1/Lb1.

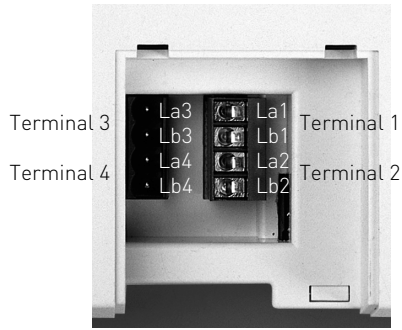

Fig. 4: Open connection panel

The connections La and Lb of the plug-in terminals are connected with connections 1 and 2 of the separate Western sockets.

You can use commercially available telephone lines for the connection.

We recommend: telephone lines J-Y (St) Y  
Length between telecommunications system and sockets: max. 800 metres at 0.6 mm wire diameter.

To close the connection panel, place the cover flat on the guides. Push the cover up sharply until it snaps audibly into place.

---

## USB interface (Universal Serial Bus)

You can connect a PC with USB interface to the USB interface of the TK system. The TK system connects the PC easily and quickly with the ISDN. It is not necessary to install an ISDN card in the PC.

Via the USB interface you can configure the TK system with the PC, read off call data and TK-

Phone and use the TAPI interface. You will also have a high-performance universal communications programme available to you through the communication software.

In chapter C "Communication through PC" you find out how to connect the PC to the TK system via USB interface and how to install the communication software.

---

## PC interface

The PC interface of the telecommunications system is a serial RS 232C interface. Here you can connect:

- a PC, for configuring the telecommunications system, for call data evaluation and computer-aided telephony (CTI). The PC connecting cable is contained in the scope of delivery.

# Telephoning

With your telecommunications system you can make free calls between the connected terminals and external calls to any external subscribers.

## Telephoning externally

For an external call, the telecommunications system seizes one of the two B-channels (lines) of the ISDN access.

In the as-delivered state, the external seizure "spontaneous with internal" is set for every connection.







This means that you immediately hear the external dialling tone when you lift handset. You can dial the desired phone number immediately.

## Telephoning internally

You can reach the internal subscribers of your telecommunications system with the internal phone numbers 11 (connection 1), 12 (connection 2), 13 (connection 3) and 14 (connection 4).

With the "external seizure spontaneous with internal" you can reach the internal subscribers by pre-dialling **#**.

## Telephoning – "External seizure spontaneous with internal" (as-delivered state)

<b>Call externally</b>						
	Lift the handset	External dialling tone	Enter external phone number	Ringing tone, subscriber is called	Subscriber answers, conversation	End call, replace handset

The spontaneous external seizure (seize outside line) is only possible directly after lifting the handset. If you want to call an external subscriber in refer back mode, you have to seize an outside line (B-channel) with "0".

also transmitted to a called ISDN subscriber providing transmission of your phone number is released.

How to account the connection costs under another MSN is described in "External seizure with specific MSN".









**Transmitting your phone number** - Bei der Externbelegung wird die Ihnen zugeordnete In the case of external seizure the multiple subscriber number (MSN) of the telecommunications system which you are assigned is transmitted to the ISDN exchange. The connection costs are saved there under this phone number. This phone number is

**Combi-device connection:** A terminal at a connection set as a combi-device (connection 4 in the as-delivered state) sends the Telephone service.

<b>Call internally</b>							
	Lift the handset	External dialling tone	Press the hash key	Internal dialling tone	Enter the internal phone no.	Ringing tone, subscriber is called	Subscriber answers, hold conversation

## Switching the external seizure







You can switch off "External seizure spontaneous with internal" and must then select **0** for external connection.

					 Off		
Lift handset	<b>EXT</b> ernal seizure spontaneous with internal	Selection	Acknowledgement tone	Replace handset			

**A further variation of the external seizure can only be set with the PC configurator.** With the "External seizure spontaneous", the telecommunications system seizes a B-channel as

soon as the handset is lifted. Internal calls and procedures are not possible. It is suitable for terminals which only operate external connections, e.g. fax or modem. \*

## Telephoning- "External seizure spontaneous with internal" off







<b>Tele- phoning externally</b>							
	Lift handset Internal dialling tone		External seizure with "0"	External dialling tone	Enter external phone no.	Ringing tone, subscriber is called	Subscriber answers, hold conversation

**External seizure at combi-device connection** - After dialling the code "1 0" at the combi-device connection (instead of "0") the telecommunications system also seizes a line. However, it identifies the connection with the Fax service. When seizing with "0", the identification is Telephony service.

number (MSN) of the telecommunications system which you are assigned is transmitted to the ISDN exchange. The connection costs are saved there under this phone number. This phone number is also transmitted to a called ISDN subscriber providing transmission of your phone number is released.

**Transmitting your phone number** - Bei der Externbelegung wird die Ihnen zugeordnete In the case of external seizure the multiple subscriber











How to account the connection costs under another MSN is described in "External seizure with specific MSN".

<b>Tele- phoning internally</b>						
	Lift handset Internal dialling tone		Enter internal phone number	Ringing tone, subscriber is called	Subscriber answers, hold conversation	End conversation, replace handset

## External seizure with specific MSN

When you have switched off "external seizure spontaneous with internal", you can select a specific MSN different to the one assigned when

dialling externally. This separates the charges, for example for private and business calls

									
Lift handset	Seize <b>MSN</b>			<b>MSN</b> ID	Enter MSN	Terminate input	Enter external phone no.	Hold conversation	

## Reserving a line

If you hear the busy tone after external seizure (e.g. with "0") both lines (B-channels) are busy. The red LED lights up. Reserve a line. As soon as a line is free, the telecommunications system

calls you. After lifting the handset you hear the external dialling tone and can enter the external phone number.

									
Lift handset	External seizure, e.g. "0", busy tone, no line free		<b>RES</b> erve a line		Acknowledgement tone		Replace handset		

---

## Notes

### External authorisation (Authorisation) -

If you hear the error tone instead of the external dialling tone when seizing an external line, your telephone is not authorised to dial an external phone number.

**Barred range** - If the barred range of the telecommunications system is programmed for your telephone, you cannot dial the external phone numbers in the barred range. You hear the error tone.

**Call internally** - possible on telephones with spontaneous external seizure which have no **#** key (hash) or do not support it.

**DTMF post-dialling** is possible for all existing connections and during a three-party conference. You can post-dial numbers and letters (**1...0**, **\*** and **#**).

**Reserved line** - The telecommunications system calls you for 60 seconds when the reserved line is free. The reservation is cancelled after 1 minute if no connection is made in the meantime.

On telephones without a **\*** key (asterisk key) or which do not support it, you have to press the number **9|9** instead of the **\*** key.

## Answering calls

You can distinguish internal from external calls by different ringing rhythms on your telephone providing your terminal supports different ringing rhythms.

You are connected with the caller when your telephone rings and you lift handset.

**Knocking** - You receive a call while you are speaking. The call knocks. You hear the internal

knocking tone once (internal call) or the external knocking tones several times (external call). You can answer the call and switch back and forth between the two calls (brokerage).

You can reject the external knocking call. If you reject it, the caller hears the busy tone if only your telephone is being called. If several telephones are being called (see call allocation) only the party with a call waiting will be disconnected.

---

### You are called



Your telephone rings



Lift handset



Hold conversation

---

### The knocking tone sounds - accept call (1<sup>st</sup> option)



You are holding a conversation and hear the external or internal knocking tone



Replace the handset



Automatic call from knocking party



Lift handset



Hold conversation

---

### The knocking tone sounds - accept call (2<sup>nd</sup> option)



You are holding a conversation and hear the external or internal knocking tone



Refer back, call is held



Pick up the external call



Hold conversation

## Reject external knocking



You are holding a conversation and hear the external knocking tones

Refer back, call is held

Reject the knocking call

Continue speaking

## Notes

Both parties hear the knocking tone. You hear the error tone when picking up a knocking call

- if the other party is the desired one in the case of internal knocking
- if both lines are busy in the case of external knocking. You have to end the first conversation

before you can speak to the knocking party (Replace handset or hold the first call with refer back).

You can prevent knocking by activating the knocking prevention function.

## Knocking prevention

If you do not want internal or external subscribers to knock, activate the knocking prevention for your

telephone. **As-delivered state:** knocking prevention off.



On



Off

Lift handset

Knocking prevention

Selection

Acknowledgement tone

Replace handset

# Transferring a call

You can transfer an external call to another internal subscriber or external subscriber. Two kinds of internal transfer are possible.

## Internal transfer with announcement

You call the internal subscriber in refer back, announce the call and Replace handset. You have then transferred the call.

## Transfer internally without announcement

You call the internal subscriber in refer back and

Replace handset without speaking to the internal subscriber. The internal subscriber receives a call. He is connected with the caller when he lifts his handset.

In the case of **external transfer**, only transfer with announcement is possible. You call the external subscriber in refer back and announce the other external call. You transfer the call by dialling the code.

---

## Internal transfer with announcement



Hold external conversation



Refer back, external call held



Enter internal phone no.



Announce external call



Transfer external call

---

## Internal transfer without announcement



Hold external conversation



Refer back, external call is held



Enter internal phone no.



Transfer external call

---

## External transfer



Holding 1st external conversation



Refer back, 1st external call is held



Seize line



Enter external phone no.



Hold 2nd external conversation



Refer back, 2nd external call is held



Transfer external call



Replace handset

---

## Notes

You must always seize the line with "0" for **external transfer**. Even when "External seizure spontaneous with internal" is switched on in the telephone.

You bear the costs of the externally transferred call.

## Internal transfer with announcement

If the internal subscriber does not answer or is busy you are re-connected with the external subscriber after . You can transfer him to another internal subscriber if necessary.

During refer back, the held external subscriber hears a melody when "Music on Hold" (MoH) is switched on internally or piped in externally.

## After an internal transfer without announcement you are called back

after 45 seconds if the internal subscriber has not answered the transferred call within this time. You are recalled immediately when the internal subscriber is busy.

If you answer the callback you will be re-connected with the external caller. If not, the call is disconnected after 60 seconds.

# Automatic dialling - Connect without dialling

You can switch on the "Automatic Dialling" on your telephone for emergencies. If you Lift handset and do not press any key, the telecommunications system automatically dials a

stored external phone number after 10 seconds. Before this, you can dial any phone number normally. Automatic dialling is not activated. **As-delivered state:** Automatic dialling off

---

## Switching automatic dialling on/off

Lift handset      **AUT**omatic dialling      Selection      Acknowledgement tone      Replace handset

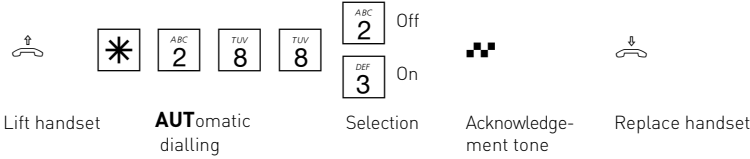

---

## Automatic dialling - Entering/deleting a phone number

Start programming mode: Lift handset, \*, 7 (PQRS), 7 (PQRS), 6 (WXYZ) (system -PIN), Acknowledgement tone, Replace handset

**P R O**

Lift handset      **AUT**omatic dialling      Selection      External ID      Acknowledgement tone      Replace handset

Continue programming or exit programming mode: Lift handset, \*, 3 (DEF), 6 (WXYZ), 3 (DEF), Acknowledgement tone, Replace handset

**E N D**

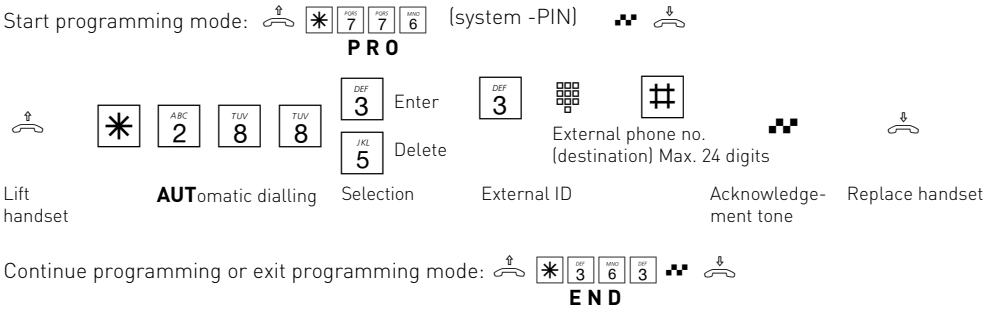

---

## Notes

Check the automatic dialling after programming the external phone numbers. Switch on the automatic dialling, Lift handset, wait for dialling of the external phone number and check that the connection is correct. If the called subscriber is busy, the telecommunications system tries to dial the external phone number again every 10 seconds.

After 12 attempts it automatically aborts automatic dialling. If you hear the error tone when switching on "Automatic dialling", no phone number is programmed. If "Automatic dialling" is switched on, you hear the special dialling tone after lifting the handset.



## Busy on Busy

A caller receives no busy tone as long as one of the two B-channels of your ISDN access is free. You hear the knocking tone during the current conversation or other telephones ring. The "Busy on Busy" function prevents this. The caller hears the busy tone if a subscriber of the ringing assignment is busy.

He then knows that you are in but are telephoning at the moment.

"Busy on Busy" can be switched on or off for every multiple subscriber number (MSN) of your telecommunications system.

**As-delivered state:** off for all MSN's

Lift handset

**BUSy** on Busy

Selection

On

Off

Enter MSN for which Busy on Busy is to be switched on/off

All MSNs

Selection:  
Busy on Busy on/off  
For single MSN  
For All MSNs of your telecommunications system

Acknowledgement tone

Replace handset

### Notes

An ISDN terminal connected parallel to the multi-equipment access and to which the same multiple subscriber number (MSN) as the telecommunications system is assigned, is always called

irrespectively of whether "Busy on Busy" is switched on or off for this MSN in the telecommunications system. The caller hears the ringing tone.

## Tracing – Identifying malicious callers

The "Malicious call tracing" feature can only be used by special order from your network provider providing he offers this service.

The ISDN exchange saves the caller's number, your phone number, the date and time of the call. You can have the caller identified during a call or after the caller replaced the receiver, but before you replaced it.

Holding external conversation

Refer back

Trace

Acknowledgement tone

Replace handset

### Notes

You can continue the conversation after **R** **\*** **3** **2** **6**.

Until you continue or terminate the conversation with the caller, the caller hears a melody if "Music on Hold" (MoH) is switched on or piped in externally in the telecommunications system.

You hear the error tone:

- if it is not possible to trace malicious callers
- if the caller can no longer be identified by the exchange

# Remote control (switch box)

Some functions of the telecommunications system can be controlled remotely by making a telephone call en route.

The following functions can be controlled remotely:

- release the telecommunications system for remote maintenance and configuration of your telecommunications system
- fix a cost limit for an internal subscriber of the telecommunications system
- switch night service on/off
- switch timer on/off
- switch diversions on/off
- switch internal transfer on/off
- room monitoring

## Operating steps for remote control:

- call the switch box of your telecommunications system with the multiple subscriber number (MSN) of the switch box.
- After 2 or 3 rings you will hear the internal music on hold (MoH) of your telecommunications system for 5 seconds.
- Wait until the music finishes.
- Enter the box PIN of the switch box as DTMF characters with a DTMF transmitter or DTMF telephone within 15 seconds otherwise the telecommunications system will disconnect the call. If you enter the correct box PIN you will hear the internal music on hold for another 5 seconds.
- Wait until the music finishes.
- You have prepared for remote control with the switch box. Now enter the procedure of the desired function from an internal telephone of your telecommunications system.

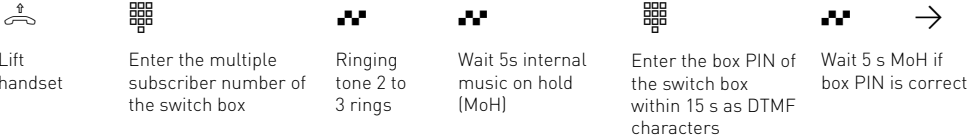

## - Enter procedure of the desired function. Example: Night service

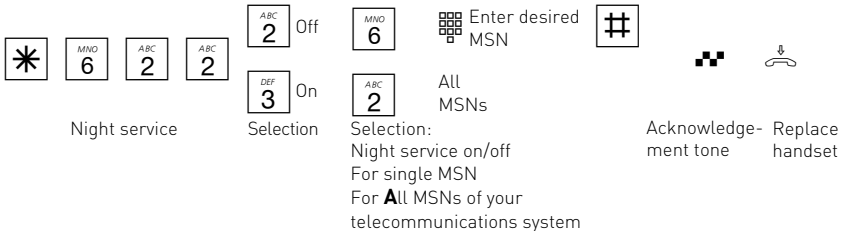

## Notes

The entered function becomes active with the acknowledgement tone at the end of the procedure. You can enter the next procedure if necessary. You break your connection to the switch box by replacing the handset.

The telecommunication breaks the connection every time the wrong box PIN is entered. After three wrong attempts, the switch box is locked for 30 minutes.

# Your switch box – Saver number

For mobiles without contractual conditions it is normal to have graduated call charges with one particularly cheap call number. You can have this number as a Saver number in your TK system. To do so indicate the MSN which you have allocated to your switchbox as the cheapest number.

When you call your saver number from your mobile you can onward dial your TK system via the phone book. The TK system will connect you via the 2.B channel (line) at the cheapest fixed network tariff.

It is an advantage if you have stored your mobile number in your TK system memory. If the switchbox identifies your mobile number when you call you can use the phone book in your TK system and be connected immediately after the acknowledgement tone.











If your mobile number is not in the memory you must select access to the switchbox as described under "remote control (switchbox)".







Once you have obtained internal access to the TK system via the switchbox you can use any remote-control function using the appropriate  procedure.

## Enter/delete mobile number

Start programming mode:      (system -PIN)  











**PRO**

					 <b>Enter</b>					
Lift handset	Mobilnumber				Selection	<b>Enter external code and number</b>			Acknowledge-ment tone	Replace handset

Continue programming or end programming mode:       





**END**

## Callthrough one the move

							 Short dial index		
Lift handset	Enter switchbox call number (Your saver number)	Acknowledge-ment tone from TK system when mobile number is identified	Phonebook	Enter short dial number 000 to 199 or <b>Vanity</b> (names)	Long tone when name has been clearly identified. The number is automatically dialled after 4 seconds or immediately after  .	FDialling tone, subscriber is called, subscriber lifts handset. Talk.			

## Notes











If you hear the engaged tone instead of the dialling tone either the subscriber or the 2.B-channel (line) is engaged. After approx. 10

seconds the engaged tone ceases and you can redial an entry in the phone book from    .

# Follow me (Diversion from)

You can divert all calls for other telephones which may not be manned to your own telephone.

You can still telephone normally with the diverted telephone. On lifting the handset, the special dialling tone reminds you that the follow me function is activated.

						Off				
Lift handset	<b>FOL</b> low me				Selection	Internal ID	Enter internal phone no. from which you want to divert calls	Acknowledgement tone	Replace handset	

## Notes







- Calls can only be diverted once. Calls diverted to your are signaled on your telephone even if you have switched on a 'Diversion to' on your telephone.
- Callback calls are not diverted.
- A "Follow me" from a telephone with activated do not disturb to your telephone is possible.

# Picking up calls







Another telephone rings. You can pick up the call on your telephone.  
If the answering machine has answered an

external call, you can pick up the external call on your telephone.

## Picking up an external call

						
External call on another telephone	Lift your handset	Pick up an external call			Hold conversation	





## Notes

Shortcut - instead of  (Pick up an external call) you can choose the shortcut  (see "Programming shortcuts").

## Picking up an internal call

								
Internal call on another telephone	Lift your handset	Pick up an internal call			Enter the internal phone no. of the other telephone	Hold conversation		

## Picking up a call from the answering machine

				
Answering machine has answered the external call	Lift your handset	Enter the internal phone number of the answering machine		Hold external conversation

### Notes

In order to be able to pick up a call from the answering machine, the terminal connection must be programmed as an answering machine.

## Conference

In a conference you telephone with two parties at the same time. Everyone hears what everyone else is saying.

As a conference party you can:





- hold a three-party conference with internal subscribers

- hold a three-party conference with an external subscriber or an internal subscriber or
- hold a three-party conference with two external subscribers. In this case both lines are busy.

### Internal three-party conference

	<b>R</b> 		<b>R</b>	<b>*</b>	<small>JKL</small> <b>5</b>	<small>MNO</small> <b>6</b>	<small>MNO</small> <b>6</b>		
You are holding an internal conversation	Refer back, enter internal phone number	Refer back call	Refer back	Conference				Acknowledgement tone	Conference with three parties

### Internal/external three-party conference

	<b>R</b> <b>0</b> 		<b>R</b>	<b>*</b>	<small>JKL</small> <b>5</b>	<small>MNO</small> <b>6</b>	<small>MNO</small> <b>6</b>		
You are holding an internal conversation or external conversation	Refer back, enter "0" and external phone number or internal phone number	Refer back call	Refer back	Conference				Acknowledgement tone	Conference with two internal and one external parties

### Notes

An external call is signalled to the conference by the external knocking tone if the called party is in a conference.

The conference leader can pick up the external call with **R** **\*** **4** **6** **3** if a line (B-channel) is free. The conference leader is no longer in the conference during the external call. He can switch back into the conference with **R** **R** providing he has not hung up.

If a subscriber hangs up he leaves the conference. He can only be called by the conference leader in HOLD and be recalled to the conference by the conference leader with **R** **\*** **5** **6** **6**.

The conference ends when the conference leader replaces his handset.

# Least Cost Routing (LCR) Cost optimised telephoning

You can program the integrated Least Cost Router on your PC with the TK-LCR (part of TK-Soft). You can define which network provider is the cheapest for your needs for eight local code areas (tariff areas) for the respective time of day and day of the week. If you have switched on the Least Cost Router, it automatically uses the entered provider based on the local code. The network code for the current network provider is placed automatically in front of its dialled external phone

number and dialled. You dial in the usual way. If the provider cannot offer a free line after a set number of attempts, the telecommunications systems automatically chooses another pre-defined provider (fallback).

You can switch the Least Cost Routing on and off on your telephone.

**As-delivered state:** LCR off

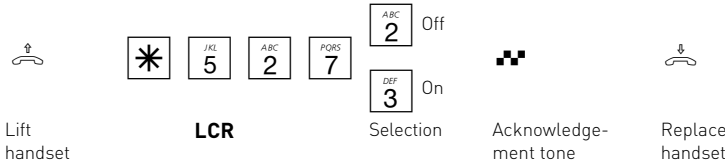

## Notes

You can decide which network provider is to be used for an external call even though the LCR is switched on:

- Just dial the network code of the desired provider in front of the local network code, e.g. 01033.

You will find a free update in Internet under [www.billiger-telefonieren.de](http://www.billiger-telefonieren.de)

Important! Not all ISDN features were available from all network providers at the time of going to print (e.g. transmission of phone number to the called party, transmission of connection costs)

## Night service

It is defined in the ringing assignment of the telecommunications system which terminal can be called under which multiple subscriber number. Two different call assignments are possible for every multiple subscriber number (MSN) in your telecommunications system with the night service and the day service.

internal or external telephone. En route, you can switch the night service by dialling the switch box of the telecommunications system with the multiple subscriber number (MSN) assigned specifically to the switch box. Also read chapter "Remote Control (Switch Box)". The day service is on when the night service is switched off.

You can switch the night service on and off individually for every multiple subscriber number of your telecommunications system from any

**As-delivered state:** For all MSN's - night circuit off.

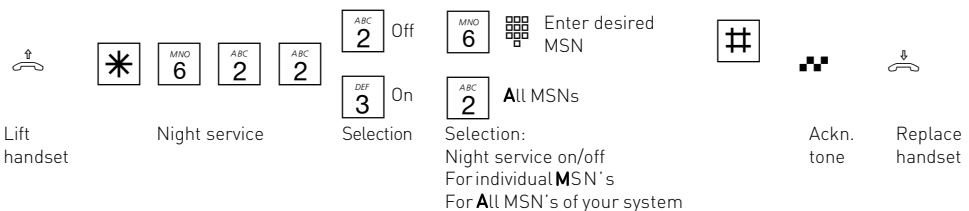

# Parking an external call

There are two ways of parking an external call:

- Parking in the telephone system. The line (B-channel) remains busy during parking.
- Parking (replugging on the bus) in the ISDN exchange. The line (B-channel) becomes free when parking in the exchange.

- you want to continue the conversation from another telephone in the telephone system  
Every internal subscriber can pick up (unpark) the external call. If two external calls are parked in the telephone system, the first external call is given priority for unparking.

## Parking in the telephone system

You can temporarily interrupt an external call and park it in the telephone system because for example

- you have to leave your desk for a moment,

If the parked external call is not recovered within 4 minutes, you will receive a recall.

The parked external call causes connection costs.





---

## Parking an external call in the telephone system

							
You are holding an external conversation	Refer back	<b>PARk</b>			Acknowledgement tone	Replace handset. The call is parked.	

---

## Recovering an external call (unparking)

					
Lift handset	<b>PARk</b>			The call is unparked, continue external call	

## Parking (replugging on the bus) in the ISDN exchange

You can temporarily interrupt an external call and park it in the ISDN exchange because for example

- you want to continue the conversation from another ISDN telephone at the multi-equipment access (bus)
- you have answered a call on the ISDN telephone at the multi-equipment access and want to continue it on an analog telephone of the telecommunications system.

The line (B-channel) becomes free when the call is parked in the exchange.

You have to continue a parked call within 3 minutes. The ISDN exchange disconnects the parked call after 3 minutes.

Since several calls may be parked at your ISDN access, you have to identify every parked call with a "connection ID".

Please see the appropriate operating instructions to find out how to park and unpark a call with an ISDN telephone.

---

## Parking an external call in the ISDN exchange

								Enter index (0 to 9) for connection ID		
Hold external conversation	Refer back	<b>IEI</b> for ISDN park			Index ID			Ackn. tone	Replace handset	

---

## Recovering (unparking) an external call



Lift handset



**IAU** for ISDN **u**npark



**I**ndex ID

Enter the index (0 to 9)  
for connection ID



Hold external  
conversation

---

### Notes

For ISDN terminals at the external multi-equipment access in which a two-digit connection ID needs to be entered for parking, enter **[0][0]** to **[0][9]**, e.g. **[0][1]**. If you want to continue the call on an analog telephone in the telecommunications system, just enter the 2nd digit, e.g. 1. The telecommunications system first tries to unpark the call with one digit but then adds a "0" to the connection ID, e.g. 01.

If you hear the error tone when parking an external call, an external call is already parked under the entered connection ID. You will be reconnected with the external subscriber after pressing **[R][0]**.

If you hear the error tone when unparking the call, no external call is parked under the entered connection ID.

Connection costs are charged for the parked external call.



# Room monitoring

Every analog telephone in the telecommunications system can be used for acoustic monitoring of the room where it is located. For baby sitting for example.

You call the monitoring phone from another internal or external telephone and listen in the room. En route, you can activate room monitoring by

dialling the telecommunications system switch box with the multiple subscriber number (MSN) specially assigned to the switch box.

You have to set up room monitoring on the telephone which is to be used for this purpose.

---

## Setting up room monitoring



Lift handset in the room to be monitored



Activate room monitoring



Acknowledgement tone



Place the handset next to the monitoring phone

---

## Room monitoring by an internal subscriber



Lift handset



Enter the internal phone number of the telephone used for monitoring



Listen into the room

---

## Cancelling room monitoring



Replace handset in the monitored room

---

## Notes

You can also use a telephone in the handsfree mode as a monitoring phone.

Please remember that you can also be heard in the monitored room when you speak.

If you hear the busy tone after dialling the monitoring phone, this means the room is already being monitored by another caller.









# Refer back / Brokerage

You can interrupt your telephone conversation and make a refer back call to a second subscriber. Your first call is placed on hold. Then you switch

back to the first call. A held external caller hears a melody if "Music on Hold" (MoH) is switched on or piped in externally.











---

## Internal refer back/Brokerage

					
Hold 1st call	Refer back 1st call is held	Enter internal phone number	Hold refer back call	Refer back call and 1st call are held	
	With "0" to external call or with internal phone no. to internal call			etc.	
Back to 1st call		Continue 1st call			

---

## External refer back/Brokerage





		 			
Hold 1st call	Refer back 1st call is held	Enter "0" and external phone number	Hold refer back call	Refer back call and 1st call are held	
	With "0" to external call or with internal phone no. to internal call			etc.	
Back to 1st call		Continue 1st call			

---

## Refer back in the room (muting)

You can interrupt your telephone conversation and speak to someone else in the room without the

person on the phone being able to hear.

			
Internal or external call	Connection is placed on hold, you can speak without the person on the phone being able to hear	Continue telephone call	Replace handset

---

## Notes

You always have to seize the line with "0" for external refer back/brokerage even when "spontaneous with internal" external seizure is set on the telephone.

If you Replace handset during a refer back call:

- transfer a held external call to the internal subscriber with which you had a refer back call
- receive a callback at-once if a call is still on hold.

The connection costs for the external call continue even when the call is on hold.

# Callback (Knocking)

The subscriber you want to reach is telephoning or does not answer. To avoid having to call back again and again, you can activate a callback. You then get a callback as soon as he hangs up or ends a call. Your phone rings. You just have to lift handset and the subscriber is called automatically.

**Callback on busy** from an external subscriber is only possible if your network provider supports the ISDN feature.

You will receive an automatic callback as soon as the subscriber is free.

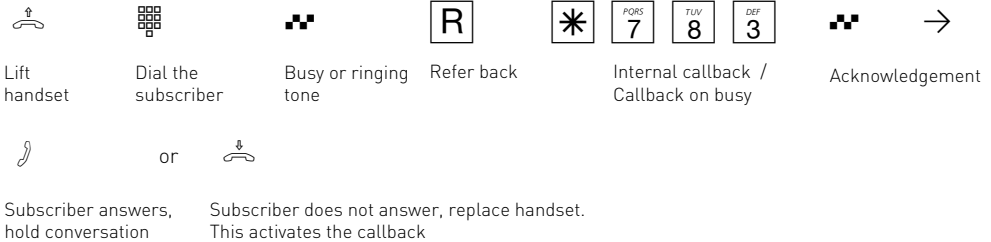

## Notes

**Callback** - you can activate several callbacks one after another (from any internal subscriber). You cannot activate a callback from an internal subscriber

- from which another subscriber is already expecting a callback
- who has switched on do not disturb on his telephone
- whose connection is set to the terminal type answering machine, fax, modem or combi-device.

Callback from an internal subscriber:

- The callback is disconnected after 60 seconds if you do not answer.
- A callback is cancelled if the callback was not connected.

General callback:  
You have activated a callback:

- If the do not disturb feature is switched on on your phone, it will be temporarily deactivated.
- If a call diversion is set up on your phone, the callback is not diverted.

In the event of a power failure: Callbacks are cancelled.

You cannot use the "Callback" features on a combi-device (phone/fax).

## Callback on busy











- No callback from the desired subscriber is possible when you hear the error tone. The ISDN feature "Callback on busy" is not available in the exchanges for example.
- If you are unavailable for callback, the callback is disconnected after 20 seconds and cancelled. Repeat the callback if necessary.
- A callback is cancelled when the callback has been connected or is not connected within 45 minutes.

## Do not disturb

You do not want to be disturbed by calls and switch off the tone call on your phone. You can still make calls as usual. On lifting the handset,

the special dialling tone reminds you that the tone call is switched off.

**As-delivered state:** Do not disturb off





		 <small>PQRS</small>	 <small>TUV</small>	 <small>GHI</small>	 <small>ABC</small> Off (do not disturb off)		
					 <small>JKL</small> Complete (all calls)		
					 <small>DEF</small> From <b>E</b> xternal calls only		
					 <small>GHI</small> From <b>I</b> nternal calls only		
Lift handset	Do not disturb			Selection		Acknowledgement tone	Replace handset



## Lock (dialling lock) – Direct call (baby call)

**Lock** - You can protect your phone against unauthorised use by locking it.

When your telephone is locked you can:

- only call internal subscribers with  and the internal phone number
- answer all incoming calls and pass them on internally if necessary.
- only dial the stored direct phone number (baby call number) and the stored number for automatic dialling externally. You have to activate the automatic dialling before locking your phone.

(Personal Identity Number). If you hear the busy tone when unlocking the phone, you have to enter the PIN after    . No PIN is defined (**as-delivered state**) for your phone if you hear the short acknowledgement tone. If you have forgotten your PIN, you will have to contact your dealer. Only he can reset the PIN.











**Direct call (baby call)** - The telephone is locked. After lifting the handset and pressing any key except  and , the stored direct number is dialled automatically. Ideal for children who are not old enough to dial phone numbers.

**Telephone PIN** - You can protect your phone against being unlocked by entering a 4-digit PIN

### Lock off / on

		 <small>PQRS</small>	 <small>ABC</small>	 <small>GHI</small> (Telephone PIN)	 <small>ABC</small> Off (unlock)		
					 <small>DEF</small> On (lock)		
Lift handset	Lock			Auswahl		Acknowledgement tone	Replace handset

### Entering / resetting the telephone PIN

		 <small>PQRS</small>	 <small>GHI</small>	 <small>MNO</small> (Telephone PIN)	 <small>DEF</small> Enter	 <small>PQRS</small>			
					 <small>JKL</small> Reset				
Lift handset	<b>PIN</b> telephone			enter the old PIN if necessary	Selection	Enter new <b>PIN</b> 4 digits (0000 to 9999)		Ack. tone	Replace handset

## Entering / resetting the direct phone number

Start programming mode:  \*    (system PIN)  

**PRO**

 \*     Enter     

  Reset

Lift handset







**DIR**ect phone number

Selection

Enter external phone number (direct phone no.) without "0" (external seizure) and without own local code

Ackn. tone

Replace handset

Continue programming or exit programming mode:  \*     

**END**

## Phonebook - Saving and dialling phone numbers

You can save 200 phone numbers in the phonebook. You can save phone numbers under a certain short dialling index with the connected terminal. It is also possible to save the phone numbers with a name on the PC.

The destinations of the phonebook can be dialled by all subscribers irrespective of their external authorisation.

In addition to external call numbers you can also save \* procedures in the phonebook. You can then also use all the procedures even on telephones which do not support \* and #.

You can select a phone number from the phonebook with the short dialling index or the name. There is no need to remember the short di-

alling index if you have the Vanity feature. Just enter the name. As soon as the telecommunications system has clearly identified an entry, you will hear the acknowledgement tone. Example:

**Entries in the phonebook**

**Selection with**

Adenauer

AGFEO

Bergmann

Cerner

## Phonebook - Dialling phone numbers

 \*      Short dialling index  

   Vanity 

Lift handset

Phonebook

Enter short dialling index 000 to 199 or Vanity (name)

Ringing tone if name was clearly identified. The destination is dialled after 4 sec or at once after 

Ringing tone, subscriber is called

Subscriber answers, hold conversation







## Notes

You can post dial further digits after dialling a phonebook destination.

You will hear the error tone (busy tone) if you dial an empty phonebook destination.

If the barred range of the telecommunications system is programmed for your telephone, you cannot dial the phonebook numbers which are in









the barred range. You will hear the error tone

Shortcut - instead of      (Execution of the telephone book with enter facility by vanity) you can choose   (**As-delivered state**, see "Programming shortcuts").

## Phonebook - Saving / cancelling phone numbers

Start programming mode:      (system PIN)  

**PRO**

      Enter  Cancel  Short dialling index 000 to 199  Continue input







Lift handset      Phonebook      Selection      Selection:

Enter short dialling index 000 to 199 under which you want to save a phone number.

Enter vanity mark and name, if the name is unequivocal in the telephone book, you hear a continuous tone. Press the key  to stop it.

    

Enter external phone number (without "0" outside line seizure) or  procedure      Finish input      Ackn. tone      Replace handset

Continue programming or exit programming mode:       

**END**

## Notes

When entering vanity names, you should care for them to be unequivocal. Enter them fully. Enter a blank between family name and christian name by pressing the key .

A name entered by telephone appears in the TK-Set as a series of numbers, because there is only an unequivocal assignment of letters to numbers.

# Timer (timing control with weekly profile)

The telecommunications system provides you with 10 timers. You can use these timers to switch the telecommunications system on or off at certain times and on certain days of the week.

The timers control the following functions:

- day, night service
- call forwarding (internal)
- busy on busy
- privilege
- lock (dialling lock)
- do not disturb
- diversion – divert call to another phone

The timers can be programmed with the TK-Set program.

You can switch every timer on and off for every telephone

En route, you can switch a timer by dialling the telecommunication system switch box with its specially assigned multiple subscriber number (MSN). Read chapter "Remote Control (Switch Box)".

**As-delivered state:** all timers off

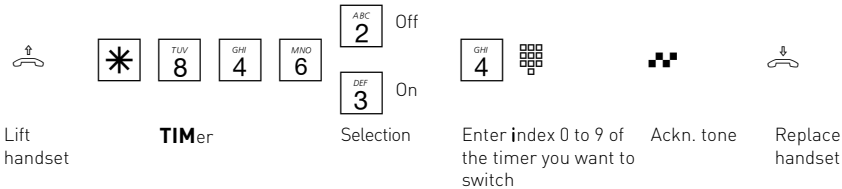

# Transmitting your phone number

Your telecommunications system offers you the possibility of suppressing transmission of your phone number (MSN) to your partner.

Two different transmission possibilities are available in ISDN:

## - Transmitting the called party's phone number to the caller

Your phone number (MSN) is transmitted to the external ISDN subscriber who calls you

## - Transmitting the phone number of the caller to the called party

Your phone number (MSN) is transmitted to the external ISDN subscriber whom you call.





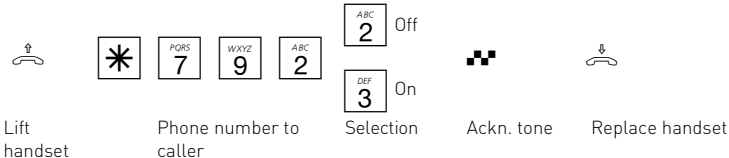

**As-delivered state:** Transmission of phone numbers to called party and caller – on.



Transmission of the phone number and its possible suppression are ISDN features and are only possible if your network provider offers them.

# Switching transmission of your phone number (MSN) to the caller on/off



## Switching transmission of your phone number (MSN) to the called party on/off





      Off

   On

Lift handset      Phone number to called party      Auswahl      Ackn. tone      Replace handset

### Notes

You local code and multiple subscriber number (MSN) [e.g. 030 87654323] assigned to you by the programming is transmitted at the **multi-equipment access**.

You can transmit another MSN for external dialling to separate the costs specifically. To seize the outside line, dial the procedure     - multiple subscriber number  external phone number instead of "0".

## Display caller number (CLIP)

See who is calling you: on analog terminals with caller number display (CLIP function) the TK system displays the caller number unless the caller has withheld it. The caller's name will also be displayed if you have stored the name and telephone number in the TK system's phone







book. The time and date will also be shown. Individual CLIP options must be activated during programming.



You can switch the CLIP function on and off on your handset.

## Display - caller number/name (CLIP): switch on/off







Start programming mode:      (system PIN)  

**PRO**

      Off

   On

Lift handset      CLIP, display caller number      Selection      Ackn. tone      Replace handset

Continue programming or exit programming mode:       

**END**



# Diversion – diverting calls to another telephone

## Diversion via the telecommunications system:

The telecommunications system diverts all calls for a fixed internal phone number to another specified destination. A diversion destination may be another internal subscriber or an external subscriber.

The telecommunications system uses both B-channels (lines) to divert an external call to another external phone number.

Despite the diversion you can still make telephone calls in the usual way. On lifting the handset, the special dialling tone reminds you that the diversion is activated.

## Diversion via the ISDN exchange:

The "ISDN call forwarding" feature can only be used if your network provider offers it.





The ISDN exchange diverts all calls made to the fixed multiple subscriber number to another external destination which you specify. The B-channels (lines) of the telecommunications system stay free.

There are three variations for call diversions: permanent, when busy or not answering after 20 seconds.



En route, you can switch a diversion by dialling the switch box of the telecommunications system with its specially assigned multiple subscriber number (MSN). Read the chapter "Remote Control (Switch Box).

The green LED of the telecommunications system flashes slowly when an external diversion is switched on.

## Programming and activating (switching on) a diversion



Lift handset                      Diversion

 Permanent  
 When **busy**  
 Not answering (after 20 s)









Enter variation

→ Continue with:  
 1) Divert internal phone number  
 or  
 2) Divert MSN

### 1) Divert internal phone number through the telecommunications system



Enter internal ID and internal phone number which you want to divert

 External phone number   

 Internal phone number  

 Short dialling index  

 Name from phonebook (Vanity)









Ackn. tone                      Replace handset

### 2) Divert MSN via the ISDN exchange

Enter MSN ID and MSN which you want to divert





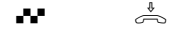







 External phone number   

 Short dialling index  

 Name from phonebook (Vanity)



Wait for ackn. tone (max. 1 minute)                      Replace handset













---

## Deactivating a diversion (switching off)

							Internal phone number		
Lift handset							MSN		
		<b>DEA</b> ctivate (switch off)			Selection: Internal phone number or <b>MSN</b>	Enter internal phone number or MSN which you want to deactivate		Wait for ackn. tone (max. 1 minute)	Replace handset

---

## Activating a diversion (switching on)

							Intern-rufnummer		
Lift handset							MSN		
		Activate (switch on)			Selection: Internal phone number or <b>MSN</b>	Enter internal phone number or MSN which you want to activate		Wait for ackn. tone (max. 1 minute)	Replace handset

---

## Notes

### Diversion via the telecommunications system

You can only program a "diversion to" for an internal phone number. When you program a diversion, you delete an existing diversion and replace it with a new one.

Your telephone may be the diversion destination of all other internal subscribers.

Diverted external calls can also be answered at telephones which only usually allow internal traffic.

Calls can only be diverted once. Calls diverted to you are signalled on your telephone even if you have switched on a diversion on your phone.

Callbacks are not diverted.

Diversions to a telephone with the do not disturb function activated are not possible.

You hear the error tone when switching on the diversion if you have selected an empty short dialling destination.

### Diversion to an external subscriber

For the external diversion

- a line must be free
- the diverter must have authorisation for the external phone number

You bear the costs for the external diversion.

### Diversion via the ISDN exchange

You can only program one diversion per multiple subscriber number (MSN).

If ISDN call forwarding is switched on, you will hear the special dialling tone of the ISDN exchange after seizing the line.

Note that up to one minute may pass between activation, deactivation and acknowledgement tone for forwarded ISDN calls. Do not Replace handset during this time.

# Connection costs

## Cost menu – Overview:

Your telecommunications system can record the costs of calls if your network operator offers the ISDN feature "Transfer connection costs at the end of the call" and the providers you use also transmit these.

For technical reasons the data on the telephone bill may differ from the connection cost totals of your telecommunications system. The network operator's tariff unit counter is always the last instance.

**PIN** (Personal Identity Number) – You can protect access to the costs menu by entering a 4-digit cost PIN. If you hear the busy tone when you start the cost menu, you have to enter the cost PIN after **\*567**. If you hear the short acknowledgement tone, no PIN is defined for the cost menu.

If you forget the cost PIN, you can change it with TK-Set on the PC or contact your dealer.

**Set decimal places** - before entering the factor for a charging unit set the number of decimal places which you wish to be shown. 0 to 3 decimal places are possible.

**Factor for a tariff unit** – Use the maximum 4-digit **user factor** (e.g. 0,06 € per unit) to define how much a tariff unit costs for every internal subscriber.

With the maximum 4-digit **basic factor**, set your telecommunications system to the amount (e.g. 0,06 € per unit) which the network operator charges for one tariff unit.

**Limit / Disconnect at limit** – You can define a 7-digit cost limit for every internal subscriber. You can also define what is to happen when the cost limit is reached. Can the internal subscriber continue the conversation he has begun but not start a new external call or will the connection be cut off. The subscriber can only make external calls again after clearing his total costs. Exception: The direct phone number can also be dialled on reaching the limit.

**Communication of charge pulses on / off** - On an analog telephone, you can display connection costs if the telephone has a units counter. To display connection costs, you must activate communication of the charge pulses for your telephone on your telephone.

If you have requested the "communication of connection charges during of the connection" feature from your network carrier, your telephone continuously displays the costs during a connection.

**Define charge pulses** -The charge pulse the PBX sends to analog telephones may be switched from 16 kHz to 12 kHz.

The analog phones available in Germany usually use the 16 kHz-pulse.

Your PABX can transmit charge pulses to analog telephones only, if your operator provides the ISDN function "Advice of charge" and your network provider is able to transmit them.

## As-delivered state:

- PIN no entry
- 2 decimal digits
- User factor 0,06 €
- Basic factor (network operator) 0,06 €
- Limit no entry
- Disconnect at limit off
- Cost log off for all subscribers
- Transmission of charge pulses activated
- Charge pulses: 16 kHz

**N. B.!** You cannot telephone as long as the cost menu is started. You hear the special dialling tone when you lift handset. You cannot telephone again until the cost menu has been exited.

## Entering /cancelling PIN for the cost menu

Start cost menu: \* (cost PIN)

**KOS**

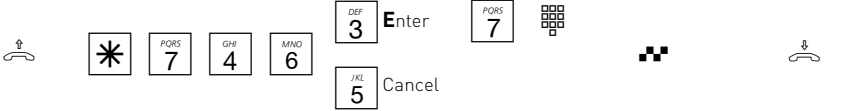

Lift handset

**PIN**

Selection

Enter 4-digit PIN

Ackn. tone

Replace handset

Continue cost menu or exit cost menu: \*

**END**

## Entering number of decimal digits for tariff units

Start cost menu: \* (cost PIN)

**KOS**

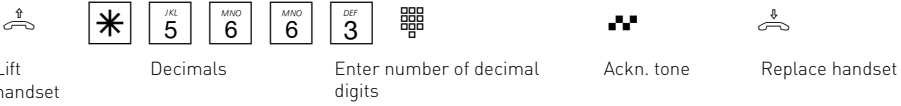

Continue cost menu or exit cost menu: \*

**END**

## Entering / cancelling factor

Start cost menu: \* (cost PIN)

**KOS**

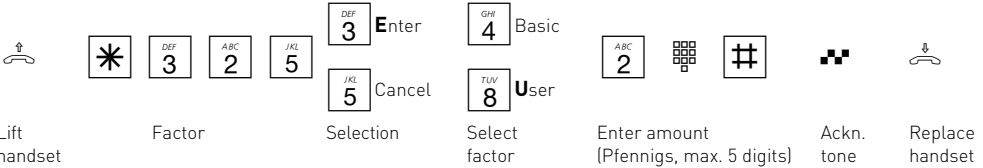

Continue cost menu or exit cost menu: \*

**END**

## Entering / cancelling limit

Start cost menu: \* (cost PIN)

**KOS**

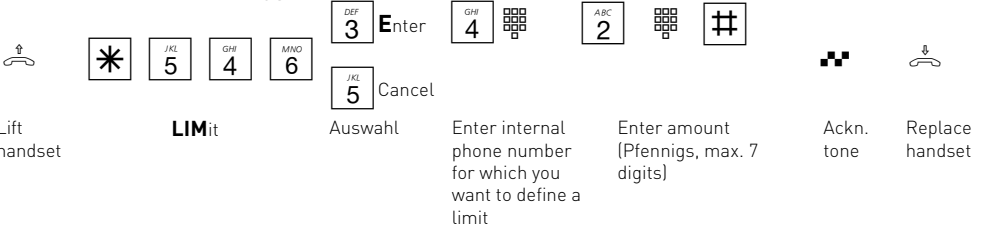

Continue cost menu or exit cost menu: \*

**END**

## Disconnect at cost limit

Start cost menu: \* 5 6 7 (cost PIN)

**KOS**

		8	7	3	2 Off		
				3 On			

Lift handset                      Disconnect                      Selection                      Ackn. tone                      Replace handset

Continue cost menu or exit cost menu: \* 3 6 3

**END**

## Communication of charge pulses on / off

Start cost menu: \* 5 6 7 (cost PIN)

**KOS**

		4	4	6	2 Off		
					3 On		

Lift handset                      Communication of charge pulses                      Selection                      Ackn. tone                      Replace handset

Continue cost menu or exit cost menu: \* 3 6 3

**END**

## Define charge pulse

Start cost menu: \* 5 6 7 (cost PIN)

**KOS**

		4	6	7	9 Twelve (12 kHz)		
					7 Sixteen (16 kHz)		

Lift handset                      Define charge pulse                      Selection                      Ackn. tone                      Replace handset

Continue cost menu or exit cost menu: \* 3 6 3

**END**

## Notes

If you want to reject your input in the cost menu and restore the setting which you saved last, exit the cost menu with 3 6 3 instead of with

\* 3 7 2

**ESC**

# Display charges for the last call

You can have the costs of your last call which are stored in the TK system displayed at any time. You must simply ensure that you have requested

"notification of costs at the end of the call from your network operator.



Lift handset

Cost of last call

Acknowledgement tone; wait until the display appears!

Replace handset

---

## Notes

If you wish to display the costs of the last connection by entering **4 3 2**, please note that your telephone's totalizer may total up the costs of the last connection.

For technical reasons, the data on the network carrier's invoice may deviate from the total connection costs displayed by the telephone system. The charge units counter in the network carrier's exchange is always binding.

## Forwarding (internal)

The telecommunications system forwards an external call to another external terminal when you switch on forwarding. The terminals of a forwarding must be defined for each MSN telephone number of your system by programming the MSN assignment.

any internal or external telephone. En route, you can switch the forwarding on or off by dialling the switch box of the telecommunications system with the specially assigned multiple subscriber number (MSN). Read the chapter "Remote Control (Switch Box)".

Forwarding takes place:

- according to a fixed number of rings if no-one answers
- immediately if the called party is busy and knocking is not possible.

The terminal to which the call is forwarded is defined for every phone number in your telecommunications system by programming the ringing assignments.

You can switch the forwarding on and off separately for every multiple subscriber number (MSN) of your telecommunications system from

**As-delivered state:** Forwarding (internal) off for all MSN's



Lift handset

Forwarding

Selection

Enter MSN's of your telecommunications system for which you want to switch forwarding on/off individually or All MSN's of your telecommunications system

Ackn. tone

Replace handset

# Programming the telecommunications system

Your telecommunications system is set after installation so that you can telephone immediately and use the functions of the telecommunications system immediately.

The programming of the telecommunications system is very flexible so that you can set it up to

meet your own personal requirements.

You have the following possibilities for programming your telecommunications system:

- Programming with a PC
- Remote configuration by the dealer
- Programming with a telephone

## Programming the telecommunications system with a PC

You can program your telecommunications system from a PC/laptop via the PC interface without knowledge of a programming language. Easily comprehensible menus guide you through

the configuration program. The "TK-Suite Set" configuration software is part of the TK-Suite software package which can be found on the enclosed CD.

---

### Minimum PC requirements

- IBM or compatible PC with hard disk and CD ROM drive
- Pentium II with a processor speed of 233 MHz or higher
- 64 MB of available hard disc space
- Microsoft Windows 2000/ME/XP
- RS 232 C interface

---

### Installing TK-Suite

See page C-2 for informations on installing TK-Suite

---

### Connecting the PC to the telecommunications system

- Connect the PC interface (D-SUB-9 socket) of the telecommunications system to the PC's COM port.
- Use a one-to-one V.24 connecting cable plug – socket for the connection. It should not be longer than 3 m.
- Start the configuration program.
- Configure the telecommunications system. Your entries are accepted interactively with user guidance.
- Disconnect the cable from the telecommunications system on completing the configuration.

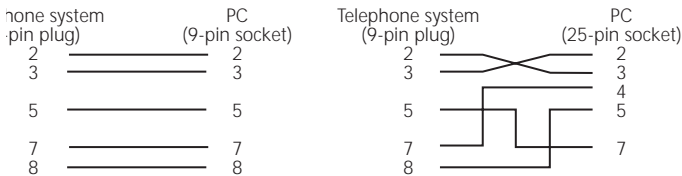

Connection assignment of the PC cable

# Remote configuration – Remote Service

Your dealer can program your telecommunications system with the remote configuration to suit your requirements. Without visiting you at home simply by using your S0 basic access. Data security is guaranteed at all times.

Before remote servicing can take place, you have to enter your dealer's remote service number or the service number of the service center in your telecommunications system.

Remote service is only possible when the saved remote service number or service number matches the transmitted phone number.

You also decide when and what can be programmed by releases. For example, whether the phonebook numbers can be read and written.

If you have released the remote service, the dealer can read out, edit and write back the programming in your telecommunications system. The remote service is allowed initially for 8 hours. The remote service is automatically barred eight hours after the last connection between the programming PC and the telecommunications system. You may have to terminate your programming for remote service.

---

## Remote configuration – Entering the remote service number

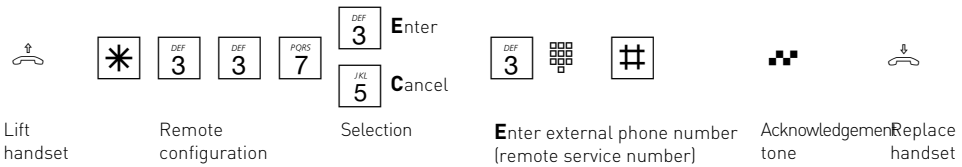

---

## Releasing the remote service

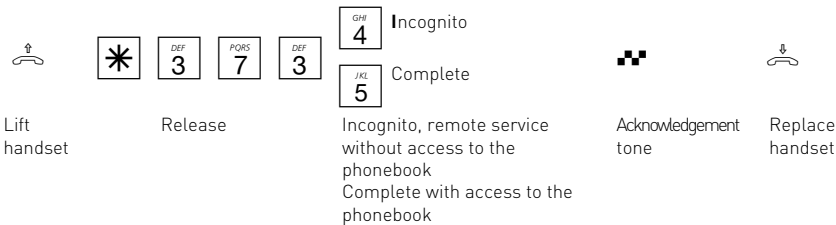



# Programming the telecommunications system with a telephone

## Notes on programming with a telephone

Programming with a telephone always involves the steps:

- Start the programming mode,
- Input
- Exit the programming mode.

Listen to the dialling tones or pulses in the earphone when programming. Wait after entering every digit until the digit is dialled. You may hear

the Acknowledgement tone if your entry is valid or the error tone (busy tone) if your entry is invalid.

Recommendation: Use a telephone with DTMF dialling for faster programming.

If you use a telephone with handsfree facilities, you can press the loudspeaker key instead of "Lift handset" or "Replace handset".

## Starting the programming mode

In order to be able to change settings, you first have to start the programming mode. Then you can make all the settings for your telecommunications system one after the other.

**N.B.!** You **cannot** use the phone whilst you are in the programming mode. You hear the programming tone on lifting the handset.



Lift handset



(system PIN)

Start **PRO**gramming mode



Acknowledgement tone, otherwise enter the system PIN



Replace the handset

## Entering the system PIN?

If you hear the short Acknowledgement tone after no system PIN is programmed in the telecommunications system. It is not necessary to enter the system PIN.

If you do not hear a tone after , a system PIN is programmed in the telecommunications system. Enter the 4-digit system PIN. If the PIN is correct, you will hear the Acknowledgement tone. If the PIN is wrong, you will hear the error tone.

## Input

After lifting the handset, enter and the first three letters of the name of the function or and the 3-digit code. Then enter other parameters (on or off, phone numbers etc.). All entries for a function are terminated by replacing the handset. If you make an error, replace the handset and start again from the beginning.

## Acknowledgement tone or error tone

If an entry is invalid, you will immediately hear the error tone (busy tone). Replace the handset and start again from the beginning.

You will hear the short Acknowledgement tone when all entries are clearly terminated and valid.

---

## Restoring old settings

You can try out settings in the programming mode. Settings are not saved until you exit the programming mode. You can restore the settings

last saved beforehand. The programming mode is then exited automatically.



Lift handset

**ESC** (old settings)

Acknowledgement tone

Replace handset

---

## Exiting the programming mode

Exit the programming mode after you have made all the settings. The new settings are then saved.

The settings are retained even in the event of a power failure.



Lift handset

**END** (exit programming mode)

Acknowledgement tone

Replace handset

---

## Restoring the as-delivered state

If the programming is unclear, you can restore the as-delivered state during the programming mode (clear memory).

**Clear memory – Attention!** All existing connections are cleared. Wait about 2 minutes! The programming mode is exited.

Start programming mode:      (system PIN)    
**PRO**



Lift handset

Restore as-delivered state

Acknowledgement tone

Replace handset

# Saving multiple subscriber numbers

Save every multiple subscriber number (MSN) which your network provider has assigned for your ISDN multi-equipment access in your telecommunications system. Your telecommunications system can save up to 10 multiple subscriber numbers. Enter every multiple subscriber number singly and without the

local network code after the following \* procedure. When you select "Fast", you save the MSN's and at the same time the terminal on which you have executed this function is also in the call assignment of this MSN.

Start programming mode: \* (system PIN) **PRO**

					Enter	Enter MSN			
Lift handset	Save MSN			Selection		Delete all MSN's	Ackn tone	Replace handset	

Continue programming or exit programming mode: \* **END**

# Defining ringing assignment

In a ringing assignment you define which terminals of your telecommunications system are to be called under which multiple subscriber numbers (MSN). You can assign one or more terminals to an MSN.

You can define three call assignments to every multiple subscriber number of your telecommunications system:

- the day service
- the night service
- the forwarding service (internal)

You can switch over the **day/night service** at any time from any telephone, even en route.

In the **Forwarding (internal)** you define to which terminals of your telecommunications system the call is to be forwarded when a call is not answered under an MSN. In this case, you define after how many ringing cycles the call is forwarded. It is forwarded immediately if the subscriber(s) of an MSN is (are) busy.

The forwarding is only active when switched on. You can switch it on and off from any telephone, even en route.

### As-delivered state:

- Day service on for all MSN's, no internal phone number entered, the internal phone numbers 11, 12 and 13 are called in the case of an external call.
  - Night service off for all MSN's, no internal phone number entered
  - Forwarding (internal) off for all MSN's, no internal phone number entered
- Cycles (number of rings) until forwarding: 5

### Internal phone numbers of your telecommunications system:



11 (connection 1), 12 (connection 2), 13 (connection 3), 14 (connection 4), 50 (switch box)

You can reach the PC connected to USB by dialling internal numbers 20 to 29.

## Day service

Start programming mode:  \*    (system PIN)  

**PRO**

 \*     Enter        

Lift handset

Day service

Selection

MSN ID







Enter MSN for which day service is defined

Internal ID

Internal phone no. which is to be called (see notes)





Ackn. tone

Replace handset

Continue programming or exit programming mode:  \*     

**END**

## Night service

Start programming mode;  \*    (system PIN)  

**PRO**

 \*     Enter        

Lift handset

Night service

Selection

MSN ID







Enter MSN for which night service is defined

Internal ID

Internal phone no. which is to be called (see notes)

Ackn. tone

Replace handset

Continue programming or exit programming mode:  \*     

**END**

## Call forwarding

Start programming mode:  \*    (system PIN)  

**PRO**

 \*     Enter        

Lift handset

Call forwarding

Selection

MSN ID







Enter MSN for which call forwarding is defined

Internal ID

Internal phone no. which is to be called (see notes)

Ackn. tone





Replace handset

Continue programming or exit programming mode:  \*     

**END**

## Notes

Several internal phone numbers can be entered

as follows: ...     ... 

All the assigned internal phone numbers are deleted when clearing a ringing assignment (day, night service or call forwarding) of an MSN.

If you want to use the telecommunication system's switch box, you should not enter the internal phone number 50 of the switch box with an answering machine in the ringing assignment of a multiple subscriber number. The answering machine may answer the call before the switch box.

## Ringing cycles before forwarding

Start programming mode: \* (system PIN)

\*

Lift handset      Cycles (number of rings)      Input ID      Number of rings (2 to 8)      **MSN** ID      Enter MSN for which forwarding is defined      Ackn. tone      Replace handset

Continue programming or exit programming mode: \*

**END**

## Setting the rhythm for external calls

You can assign different ringing rhythms to 5 MSN's in order to be able to hear from the ringing whom the caller wants to speak to.

**As-delivered state:** Rhythm 0 (standard) for all MSN's.

Start programming mode: \* (system PIN)

\*

Lift handset      **Rhythm**      Enter, rhythm 0 to 4      Enter **MSN** for which the rhythm is to apply      Acknowledgement tone      Replace handset

Continue programming or exit programming mode: \*

**END**

## Notes

All ringing rhythms for incoming external calls start with an initial ring of 500 ms. This is followed by a 2 s pause. This is for technical reasons to transmit the phone number of the caller (CLIP).

Then it is possible to distinguish calls under different multiple subscriber numbers (see the diagram).

### Ringing rhythms

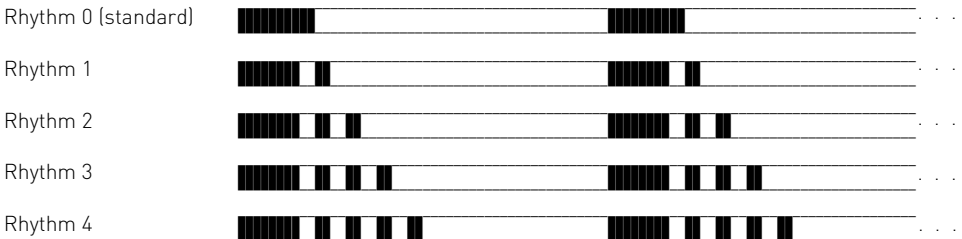

The calls may deviate depending on the terminal used.

# Programming access to the ISDN network

You define which multiple subscriber number(s) of the telecommunications system every internal subscriber can use to set up an external connection. The connection costs are registered under this multiple subscriber number (MSN) which is transferred to the called party.

You define one of the three authorisations for every MSN:

**Preferred** – this MSN is transmitted automatically in the case of external seizure “spontaneous with internal” or with “0”.

**Free** – these MSN’s can be selected for external seizure by the internal subscriber. On the telephone by entering and the MSN. This is only possible when the external seizure “spontaneous with internal” is switched off. If the internal subscriber is authorised for several multiple subscriber numbers, the first assigned MSN is transmitted spontaneously at external seizure or with “0”.

**Barred** – this MSN is barred for the internal subscriber.

**As-delivered state:** All internal subscribers have free access to the ISDN network through every MSN.

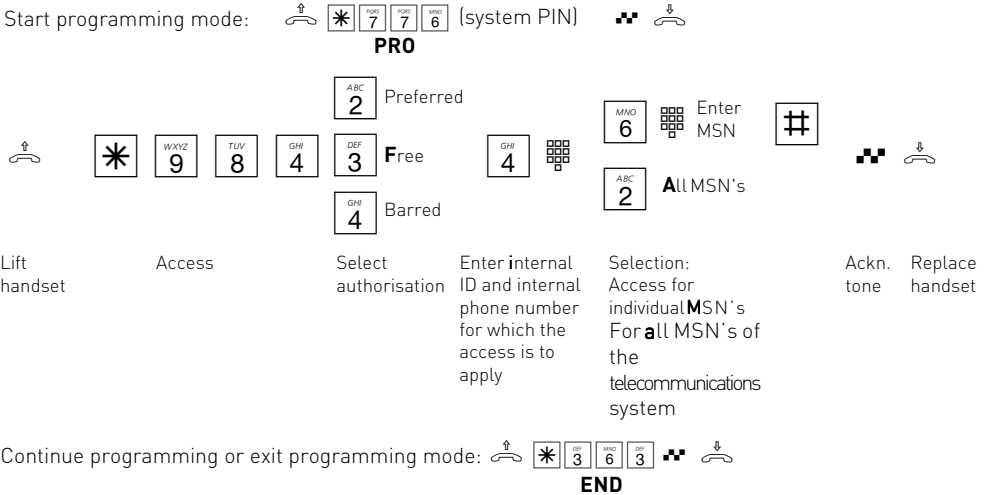

# Defining authorisation

Normally every subscriber can telephone all over the world.

However, you can define how far every single phone may call:

- non-restricted
- domestic
- regional numbers table (the regional numbers must be entered additionally)
- City/local calls
- none (only answer incoming calls, semi-restricted)

**As-delivered state:** non-restricted for all subscribers

Irrespective of the authorisation, you can define that every subscriber cannot dial certain phone numbers (programmed under "Barred numbers").

Start programming mode: \* (system PIN)

**PRO**

		Full							
		Domestic							
					Table regional				
		City/Local							
		None							
Lift handset	Authorisation	Selection		Enter internal ID and internal phone number for which the authorisation is to apply			Ackn. tone	Replace handset	

Continue programming or exit programming mode: \*

**END**

## Notes

All subscribers can dial all the phone numbers in the phone book irrespective of the programmed authorisation.

Phonebook numbers which are barred by the barred numbers function cannot be dialled by subscribers with the "Barred numbers" assignment.

# Programming regional numbers (free range)

You have defined how far a telephone may call under "Authorisation". If you have set "Table regional numbers" there, you can program up to 10 codes (index 1 to 9, 0, max. 6 digits) which you can define as a region.

If you enter 022 for example, the subscriber with regional authorisation can dial numbers

beginning with 022 in addition to making local calls:

- He can dial e.g.: 0221, 0228, 02241, 0228.
- He cannot dial e.g. 0211, 0231, 0288.

**As-delivered state:** No regional numbers defined.

Start programming mode: \* (system PIN)

**PRO**

					Enter					
Lift handset	Regional numbers	Selection	Enter index ID and index 1, 2 ... 9, 0	Enter code ID and code number max. 6 digits	Ackn. tone	Replace handset				

Continue programming or exit programming mode: \* (system PIN)

**END**

# Programming barred numbers

You can bar 10 number (index 1 to 9, 0) ranges. Barred numbers beginning with these codes cannot be dialled. The barred numbers can be assigned to every subscriber in the

telecommunications system additionally irrespective of the authorisation.

**As-delivered state:** No barred numbers defined, no barred numbers assigned.

## Entering barred numbers

Start programming mode: \* (system PIN)

**PRO**

				Enter					
Lift handset	Barred numbers	Selection	Enter index ID and index 1, 2, ..., 9, 0	Enter code ID and code number max. 6 digits	Ackn. tone	Replace handset			

Continue programming or exit programming mode: \* (system PIN)

**END**



## Assigning the barred numbers

Start programming mode: \* (system PIN)

**PRO**

		WXYZ	TUV	WXYZ	ABC Off	GHI		
Lift handset	Assign barred numbers				Selection	Enter internal ID and internal phone number	Acknowledgement tone	Replace handset

Continue programming or exit programming mode: \*

**END**

## Entering terminal types

Settings are available dependent on the connected terminal types. Certain functions are then automatically active.

### Make the setting on every terminal:

- **Telephone:** The knocking prevention is switched off and can be switched on. A call with the "Fax" service ID is not signalled.
- **Answering machine:** The knocking prevention is switched on permanently. Anyone can pick up a call from this connection.
- **Fax:** The knocking prevention is switched on permanently. A call cannot be picked up. The "Fax" service is transmitted. Calls with the "Fax" service ID are always signalled at this connection.
- **Modem:** The knocking prevention is switched on permanently. A call cannot be picked up.
- **Combi-device:** A combi-device is a telephone with integrated fax. In the combi-device a call is

generally assigned where it is to be signalled according to the set ringing assignment irrespective of the transmitted service ID. In the case of external seizure with "0", use the "Telephone" service. In case of external seizure with "10" use the "Fax" service. The knocking prevention is switched on permanently.

### As-delivered state:

- Connection 1 – telephone, internal phone number 11
- Connection 2 – telephone, internal phone number 12
- Connection 3 – answering machine, internal phone number 13
- Connection 4 – combi-device, internal phone number 14

Start programming mode: \* (system PIN)

**PRO**

		TUV	WXYZ	PQRS	DEF Enter	TUV	TUV	DEF	JKL	<b>TELE</b> phone		
Lift handset	<b>TYPE</b> of terminal				Selection	<b>Vanity</b>	Selection			Ackn. tone	Replace handset	
					JKL Delete (telephone)			ABC	MNO	PQRS	Answering machine	
								DEF	ABC	WXYZ	<b>FAX</b>	
								MNO	MNO	DEF	<b>MOD</b> em	
								JKL	MNO	MNO	Combi-device	

Continue programming or exit programming mode: \*

**END**

# Programming short commands

You can program a function which you want to use frequently as a short command.

Two short commands which you can select with **\*0** or **\*1** on every telephone are available in your telecommunications system.

The following standard functions are stored as short commands in the **as-delivered state**:

**\*0** = **\*835** <sup>TUV</sup> <sup>DEF</sup> <sup>JKL</sup> <sup>TUV</sup> <sup>8</sup>

(Call the phonebook with Vanity input)

**\*1** = **\*463** <sup>TUV</sup> <sup>ABC</sup> <sup>DEF</sup> <sup>JKL</sup> <sup>TUV</sup> <sup>4</sup> <sup>ABC</sup> <sup>DEF</sup> <sup>JKL</sup> <sup>TUV</sup> <sup>6</sup> <sup>DEF</sup> <sup>JKL</sup> <sup>TUV</sup> <sup>3</sup>

(Pick up an external call)

You can program any function as short command 0 or 1. Every function starts with **\***.

You can also combine several functions in one short command.

Example: Entering / cancelling limit  
Enter the individual functions after index 0 or 1. Do not replace the handset!

**\*667** .... - start cost menu

**\*546** .... - entering / cancelling limit

**\*363** .... - exit cost menu



If you replace the handset before terminating the short command input with **\*687**, the entry will be cancelled.

If you delete or cancel a short command input, the appropriate standard function is programmed again.

Start programming mode:  **\*776** (system PIN)  

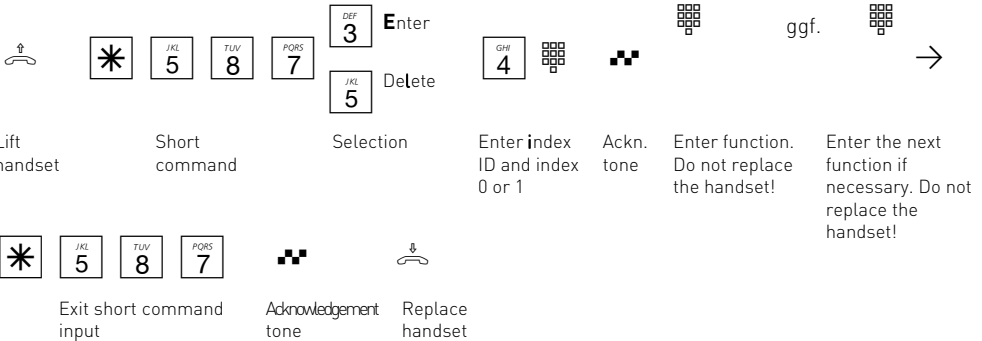
**PRO**



Continue programming or exit programming mode:  **\*363** <sup>DEF</sup> <sup>ABC</sup> <sup>DEF</sup> <sup>JKL</sup> <sup>TUV</sup> <sup>3</sup> <sup>ABC</sup> <sup>DEF</sup> <sup>JKL</sup> <sup>TUV</sup> <sup>6</sup> <sup>DEF</sup> <sup>JKL</sup> <sup>TUV</sup> <sup>3</sup>  

**END**

# Setting list of callers

The telecommunications systems saves external calls which no internal subscriber has answered in a list (call list). You can display and print the list with the "TK-Phone" program on the PC. The "TK-Phone" program is part of the TK-Soft software package.

## 1. Interrogate selection:

- Off – no list of callers is saved for this connection.
- Phone number – All external calls which transmit the phone number are saved for this connection.
- Phonebook – Only those external calls which transmit the phone number and are listed in the telecommunication system's phonebook are saved for this connection.

## 2. Specify to whom the selection should apply:

- Internal subscriber (eg 11)
- All internal subscribers

**As-delivered state:** Off – no list

The call list contains the following information:

- date and time of the call
- phone number/name of the caller (if the phone number is not transmitted, the caller's phone number is marked "unknown")
- multiple subscriber number of the internal subscriber
- service (telephony, fax, data)

The green LED of the telecommunications system flashes rapidly when an entry is saved in the list. The LED stops flashing rapidly when the list has been read out with "TK-Phone".

Start programming mode: \* 7 7 6 (system PIN)

									Off			Internal phone number		
									Phone number			All internal phone numbers		
									Phonebook					
Lift handset	<b>LIS</b> t of callers (call list)	Selection	Selection:	Enter internal ID and internal phone number or	<b>All</b> internal phone numbers	Acknowledgement tone	Replace handset							

Continue programming or exit programming mode: \* 3 6 3

# Brokerage – Setting the variant

In brokerage you switch back and forth between two parties. One subscriber is held whilst you are speaking to the other one and cannot hear what you are saying. For brokerage with external subscribers, you can define whether the brokerage (Hold) is to take place in your telecommunications system or in the ISDN exchange (Exch).

Difference when brokering with two external subscribers:









**Brokerage in the telecommunications system –**  
The two lines (B-channels) are busy. Another external connection is not possible.







**Brokerage in the Exch (HOLD) –** Only one line (B-channel) is busy. The 2<sup>nd</sup> B-channel is free for another external connection.

**As-delivered state:** Brokerage in the telecommunications system

Start programming mode:  \*    (system PIN)  

**PRO**

					 Off		
			 On				
Lift handset	Brokerage in the exch	Selection	Acknowledgement tone	Replace handset			

Continue programming or exit programming mode:  \*     

**END**

# Setting the flash time

Analog telephones with DTMF (dual tone multi-frequency dialling) require a flash key (R-key or signal key) among other things to transfer calls. You can adapt the telecommunications system to different flash times of the telephones. The flash time of your telephone is listed in the telephone's technical data.

**As-delivered state:** flash time – 50 to 600 ms









Proceed as follows on the telephone to test whether the set flash time is correct:







- set up external call
- press the Flash key
- the time is set correctly if you hear the internal dialling tone
- the connection is cut off, flash time in the telecommunications system is set too short.

**Set the flash time at the terminal connection to which it is to apply.**

Start programming mode:  \*    (system PIN)  

**PRO**

								
Lift handset	<b>FLASH</b> time	Input ID	Enter flash time range	Acknowledgement tone	Replace handset			
			2 = 50 to 200 ms					
			3 = 50 to 300 ms					
			4 = 50 to 400 ms					
			5 = 50 to 500 ms					
			6 = 50 to 600 ms					

Continue programming or exit programming mode:  \*     

**END**

# Programming Music on Hold

Define whether the held caller is to hear music on hold (MoH) when you make a refer back call or forward a call.

**As-delivered state:** Internal Music on Hold

You will hear 1 melodie in succession when you select the internal MoH.

Start programming mode: \* (system PIN)

**PRO**

				Off		
			Internal MoH			
Lift handset	<b>Music On Hold</b>		Selection		Acknowledgement tone	Replace handset

Continue programming or exit programming mode: \*

**END**

## Sending zero

Terminals which support the CLIP function (phone number display) may have a call list. This allows simple dialling of unanswered calls. If you have switched off the external seizure "spontaneous

with internal" on this terminal, you have to switch on the "send zero" function.

**As-delivered state:** Send zero – off

Start programming mode: \* (system PIN)

**PRO**

				Off		
			On			
Lift handset	<b>Send zero</b>		Selection		Acknowledgement tone	Replace handset

Continue programming or exit programming mode: \*

**END**

P

# CLIP function, set options

On analog terminals with caller number display (CLIP function) the TK system displays the caller number provided this transmitted by the caller or his network operator.

For the CLIP function, you may select one out of several options, given the terminal's support of the chosen option:

- display **name** of caller. The caller's name and number must be stored in the TK system phone book.
- display caller's number (**Phone number**)

- display **time and date**
- **Off** - no CLIP function for all subscribers

If you wish to set several options you have set each option individually, using procedur - \* each time.

**As-delivered state:** caller number ON

In order to use the CLIP function you must switch the CLIP function on at the terminal (see operation - display caller number (CLPI)).

Start programming mode: \* (system PIN)

## PRO

			<b>Name</b>			
			<b>Date/Time</b>			
			<b>Phone number</b>			
Lift handset	Set CLIP option	Selection	Acknowledgement tone	Replace handset		

Continue programming or exit programming mode: \*   
**END**

# Protecting the programming mode and switch box against unauthorised access

You can prevent unauthorised access to the programming mode with a system PIN (**P**ersonal **I**dentify **N**umber).

You can prevent unauthorised access to the switch box by a box PIN.

**System PIN** – Normally every subscriber can program. With the 4-digit system PIN, you can prevent unauthorised starting of the programming mode. This protects your telecommunications system settings (e.g. authorisation of the internal subscribers) against unwanted changes. Programming is only possible when the system PIN has been entered after when the programming mode is started. You can switch the system PIN on or off or change it. In the **as-delivered state**, the system PIN is always 2580 (standard PIN), this is the middle keys from top to bottom. The standard PIN is switched off.

You can enter your own new PIN for better security.

The standard PIN or the new system PIN must be switched on and off separately.

If you forget your own system PIN you cannot do any more programming. In this case you will have to consult your dealer. Only he can reset the PIN.

**Box PIN** – You can dial the switch box of your telecommunications system en route from any telephone, e.g. to switch over the day/night service or set a diversion. You can protect the switch box against unauthorised access with the 4-digit box PIN. No box PIN is programmed in the **as-delivered state**. You have to enter a box PIN if you want to use the switch box.

## Programming a system PIN

Start programming mode: (system PIN)

**PRO**

Off

On

**Standard PIN**

Enter **new PIN**

Lift handset      System pin      Selection      Enter PIN ID and 4-digit system PIN      Acknowledgement tone      Replace handset

Continue programming or exit programming mode:

**END**

### Enter system PIN?

If you hear the Acknowledgement tone after , the system PIN is switched off in the telecommunications system. There is no need to enter the system PIN.

If you do not hear any tone after , a system PIN is programmed in the

telecommunications system. Enter the 4-digit system PIN. You will hear the Acknowledgement tone if the PIN is correct. If the PIN is incorrect, you will hear the error tone (busy tone). Replace the handset and start the input again from the beginning.

## Programming the box PIN (switch box PIN)

Start programming mode: \* (system PIN) **PRO**

\* Enter   
 \* Delete

Lift handset      **BOX** pin      Selection      Enter **PIN** ID and 4-digit switch box PIN      Acknowledgement tone      Replace handset

Continue programming or exit programming mode: \* **END**

## Entering the code

Enter your code (local network code). This saves you having to enter the code for phone numbers in the phonebook of your local network.

The code is automatically prefixed to the transmitted phone number.

Start programming mode: \* (system PIN) **PRO**

\* Enter   
 \* Delete

Lift handset      Local code      Selection      Enter code ID and code number      Acknowledgement tone      Replace handset

Continue programming or exit programming mode: \* **END**



## Loading new firmware

You can update your AGFEO ISDN telecommunications system to the latest firmware state without manipulating the telecommunications system. You can load the new firmware with a PC at the PC interface or at the

USB interface of the telecommunications system. Your dealer can also load the new firmware in your telecommunications system remotely by ISDN.

---

### Backing up the telecommunications system data

- Start the "TK-Suite Set" configuration program on your PC.
- Read all the data from the telecommunications system.
- Save the data on the hard disk or a diskette.
- Save the LCR table.

---

### Loading new firmware

- A firmware update consists of the files *xxx.abf* and *xxx.bin*. These files may be combined in a self-unpacking file (*xxx.exe*).
- The files *xxx.abf* and *xxx.bin* must be in the *Updates* directory of TK-Soft.
- (...)\tksoft\updates)
- Start the update program "TK-Flash"
- The online help will tell you how to operate "TK-Flash".

The new firmware is now loaded in the telecommunications system. You cannot use the telephone during the loading process (about 5 minutes). You can follow the loading progress on the PC monitor.

- Exit "TK-Flash".
- Clear the telecommunications system memory from the telephone.

---

### Clearing the memory from the telephone

Start programming mode:  \*    (system PIN)  

**PRO**



Lift handset



As-delivered state (clear memory)



Acknowledgement tone



Replace handset

The memories are cleared!

---

### Loading telecommunications system data

Load the saved system data from the PC back into the telecommunications system.

The telecommunications system now operates with the new firmware.



# Communication through PC

---

## Software overview

The enclosed CD-ROM contains the following software: TK-Suite Basic and the TAPI and USB drivers. There is also the NDISWAN Driver for the AC 14 WebPhone. To be friendly to our

environment we have not included printed version of the individual programs as help will be available in each program by just clicking on the question mark.

---

## Program components of software package TK-Suite

**TK-Suite Server** contains the following components, TK-Suite Set, TK-Suite Bill and TK-Suite contact. TK-Server is a program which runs in the background under Windows ME and as a service under Windows 2000/XP. This means that you do not work directly with the program but with the TK-Suite-Client and an Internet Browser application.

**TK-Suite Set** You can program the telephone system from your PC with TK-Suite Set. Call forwarding, ringing rhythms, day/night service and all ISDN parameters can be set quick and easy. With TK-Suite set you can save the telephone system configuration on your hard disc. If required you can send this back up data back to the telephone system. (see Chapter "Programming of the Telephone System")

With the LCR component of TK-Suite Set you will be able to reduce call cost of your telephone system, provided your LCR table is kept up to date, by using the most cost effective service provider. Should this line be busy, then the automatic fallback function of the system will automatically select the next alternative service provider. A individual routing table can be created at any time to ensure cost effective phone calls. Should you like to take advantage to use a provider on a "call by call" \* selection, without being registered to this or having an account, then this is also no problem. Up to eight providers with their dialling codes can be selected in a weekend profile. In addition you can select up to eight tariff tables.

\*Network dependent telephone integration)

**TK-Suite Bill** is for the analysis of your call data. If your service provider should forward call charge information, then the software will record all call charges. TK-Bill will sort and calculate per extension, date, telephone number or customer. In addition a sort of all calls per providers is also available. TK-Bill will not only record calls cause a charge, but also records incoming calls.

**TK-Suite Contact** is your personal telephone and address book with multi user functionality. It is possible to import the phone book data of the telephone system into TK-Suite Contact. It works closely together with TK-Suite Client to give you a fully functional CTI working environment.

**TK-Suite Client** serves to integrate all TK-Suite components in your desktop so that it is possible to access each tool per mouse click. In addition TK-Suite Client offers you a fully functional CTI workplace with the ability to call telephone numbers from TK-Suite Contact, display incoming calls and reminders with the resubmission function.

## Installing TK-Suite

Start the installation routine of TK-Suite. After you selected the installation folder and start up group, you will be asked from the TK-Suite Basic installation routine if the application should be installed as Single Work Station, Server – or Client version.

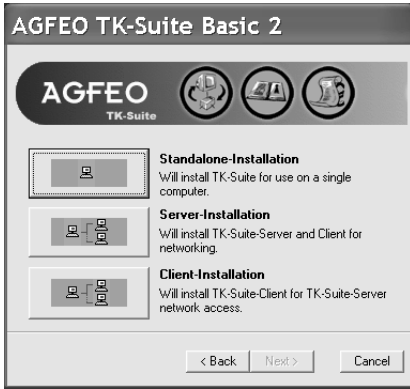

Select **Single User** if you would like to use the Telephone System with one PC only.

Select **Server** if you would like to use the Telephone System with more than one PC.

Select **Client** if you would like to use the Telephone System with more than one PC and have already installed the Server Version to which you have access. Please ensure that the User Setting has already been prepared on the Server for the Client.

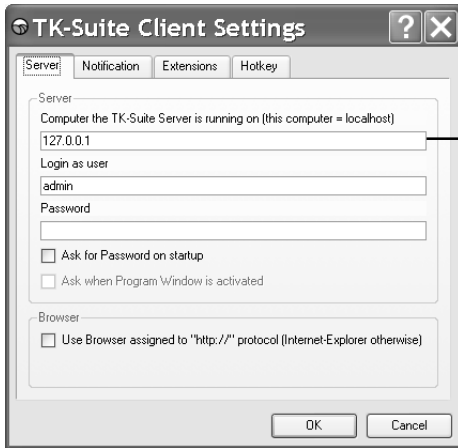

You will be asked for the Server Name, User Name and Password if you install TK-Suite Client to access TK-Suite Server on the network. Name and Password should have been allocated before in the TK-Suite Server version.

You select between an active or passive connection on installing TK-Suite Basic.

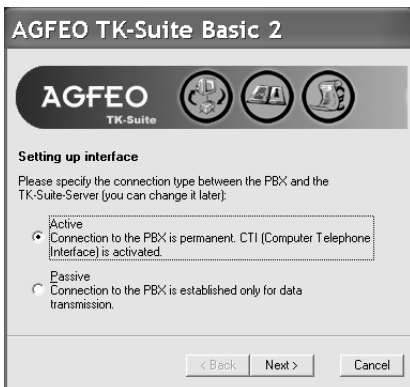

### ACTIVE:

The connection to the Telephone System is permanent and the port to which the computer is connected is constantly in use and not available for any other application. A sensible choice for a Server or Single User if the CTI application should be used constantly.

### PASSIVE:

The connection to the telephone system will only be established on programming or transfer of call charge data. The port may be used by other applications when not in use. CTI is **not** possible with this setting.

Afterwards you may select the type of connection to the system:

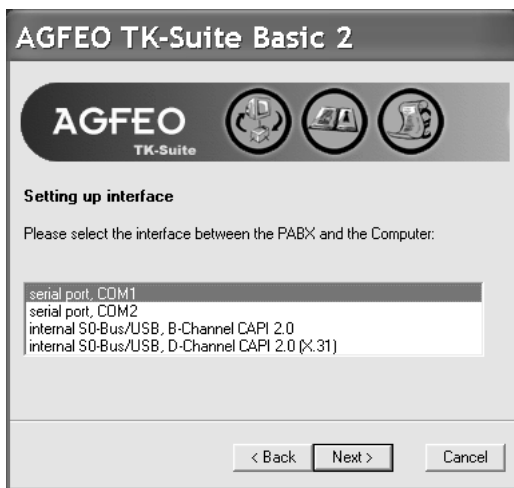

- Com1 or Com 2 if you want to communicate via the serial port with the system.
- Internal SO/USB Capi 2.0 if you want to communicate via the USB or ISDN connection. This type of connection does not support CTI and will not be offered if you have selected "Active" before hand.
- X31 if you want to communicate with the system via the internal SO or USB connection and not to engage a speech channel of the internal SO of the system.

To use CTI you must communicate with the system either via the serial port or via the X31 protocol.

---

## CTI - Computer-assisted calling via TAPI interface

TAPI - (Telephony Applications Programming Interface) in contrast to TK-Phone is not a stand-alone CTI application but an interface between a TAPI-compatible Windows application and the TK system. Provided programs (applications) support this interface, it is possible to control the TK system. The extent of control depends on the application used. However it usually includes starting outgoing calls (selection from the application) and display of incoming calls.

TAPI is a Microsoft Operating Systems interface and the application side of the Microsoft-Telephony-Interface. To connect this interface to the TK system a Telephony-Service-Provider (TSP) from the manufacturer of the ISDN hardware is necessary, in this case AGFEO. The

TSP is a driver which you must install on your PC. It executes the required TAPI functions and controls the necessary data exchange between the PC and the TK system. Because of the continually growing function capability of TAPI-assisted applications the TSP needs to be continuously expanded. So that you always have the current TSP available we make the TSP available to you on our Internet homepage at <http://www.agfeo.de>.

The self-unpacking file contains all the information necessary for installation and for the applications supported. If you do not have internet access please contact your dealer. The TSP will be sent to you free of charge.

C

---

## System requirements

The following are system requirements for installation of the software packages:

- Pentium II with a processor speed of 233 MHz or higher
  - 64 MB of available hard disc space
  - Microsoft Windows 2000/ME/XP
- Should you like to run TK-Suite with several

clients then we would like to suggest to use Windows 2000 or XP as platform of your server installation.

---

## Set up USB connection

You can connect the TK system to a desktop PC or notebook via the USB interfaces.

1. Take the USB cable supplied (identified by the USB symbol on its plugs)
2. Plug the square plug [B-plug] for the USB cable into the USB socket on the TK system

3. Plug the flat plug [A-plug] on the USB cable into one of the USB connections on your computer
4. Switch your computer on.

When you first start up Windows with the TK system you will be asked to specify the position of the driver. For further details see section „Install driver software“.

---

## Install driver software

**Important !** If you have already installed an ISDN card from a different manufacturer in your computer you must first remove this. Follow the instructions in the manufacturer's handbook.

During the software installation, you are possibly requested to insert the operating system CD. Get your operating system CD.

Before you install the driver software the TK system must be connected to the PC via the USB interface.

1. When the PC has recognised the TK system connected to it the „Hardware Assistant“ appears. The Hardware Assistant installs the software for a new hardware component (AGFEO AC 14 USB). Click on „continue“.
2. In the next dialog window select „Look for the best driver for the equipment [recommended]“ and click on „continue“.
3. Activate the option „CD-ROM“ in the next dialog window and de-activate all other boxes. Place the CD in the CD-ROM slot and click on „continue“.

4. Once the drivers have been found, click on „continue“ to start installation.
5. The drivers will be installed.
6. Under "ISDN configuration" you read the note text and click on "continue".
7. Select the D-channel-protocol: "DSS!: Euro-ISDN" and click on "continue".
8. Now you are requested to input the telephone number(s). Enter the internal telephone number(s) for the PC at the USB link. The internal call numbers 20 to 29 are available (see system programming under port allocation). Click on "continue".
9. The ISDN configuration is finished. Click on "finish".
10. On request, insert the operating system CD, in order to load the USB support. After the software for the new device was installed, click on "finished".
11. Once installation is completed, start your PC up again.

**If you want to modify the telephone number(s) for the PC in the USB link later:**

Select " start / programs / accessories / communication / Assistant for ISDN configuration".

1. Under "ISDN configuration" you read the note text and click on "continue".
2. Select the D-channel-protocol: "DSS1: Euro ISDN" and click on "continue".
3. Now you are requested to input the telephone number(s). Enter the internal telephone

number(s) for the PC at the USB link. The internal call numbers 20 to 29 are available (see system programming under port allocation). Click on "finished".

4. The ISDN configuration is finished. Click on "continue".
5. For the termination of the installation you restart your PC.

---

**Uninstall driver software**

If you don't need the driver software anymore, you can uninstall it.

Remove the AC 14 USB in the Device Manager

(find under System setup / System / Device Manager / Network cards / AGFEO ISDN AC 14 USB).

# Connections to Internet or other network

These instructions show you how to connect to the Internet or other network with the Microsoft remote data transmission network.

1. Open (double-click) the symbol „workplace“ on the desktop.
2. Open (double-click) the symbol „DT network“. The DT network is automatically installed as standard in Windows 98. If the remote data transmission network does not appear under „workplace“, you can still install it. Select „Start / setup / system control / software“. Further information can be found in the Windows Help index under „Software, install components“.
3. If this is the first connection, click on „continue“. Otherwise open (double-click) „Create new connection“.
4. In Help enter a name for the connection eg the name of your provider.
5. Under „Select device“ select „AGFWMP-Line 1“ and click on „continue“.
6. Enter the ISDN dialling number for your Internet provider or the remote network and click on „continue“.
7. Click on „complete“. A symbol for this connection will appear.

## Configure connection

1. If the remote data transmission network is not open: Open (double-click) the symbol „workplace“ on the desktop. Open (double-click) the symbol „remote data transmission network“.
2. Open the dialog window in which you can configure your connection. Click with the right mouse key on the symbol for the previously installed connection and select „Properties“.
3. Activate the registration card „Server types“. Execute the following steps:
  - If you are setting up an Internet connection, deactivate „Register with network“.
  - Activate „software compression“.
  - For connections to the Internet activate only „TCP/IP“ as the protocol.

## Dialling the Internet or other network

Once you have set up the connection to your internet provider or the network as described you can now dial into the corresponding network. If you want to surf the net or access your e-mail you must have a web browser or e-mail application installed.

To connect, follow these steps:

1. Open (double-click) the symbol „workplace“ on the desktop.
2. Open (double-click) the symbol „remote data transmission network“.
3. Open (double-click) the symbol for the connection set up previously
4. In the dialog window „connect to“ do the following:  
Input the name made available by your internet provider and the code word.  
Click on „connect“.  
As soon as the connection is made the dialog window „connected to“ appears.
5. You can now surf the internet with your web browser or access your e-mails with an e-mail application.

## Disconnecting

To disconnect click on the dialog window „connected to“ on „disconnect“.

If this window has minimised to a symbol, click on the symbol in the task bar.



# Glossary

## Services

A service identification (ID) (e.g. telephony, fax) is transmitted in ISDN when an ISDN subscriber is called. The caller is only connected if the called terminal has the same service ID. This prevents wrong connections of two different terminal types (e.g. phone and fax).

## DT - network

With the Microsoft Windows data transmission network your computer can accept a connection to an internet service provider.

## Terminals

Appliances which you connect as internal subscribers of the telecommunications system. Analog terminals such as telephones, answering machines, fax machines, combi-devices (telephone, fax and possibly answering machine in one unit), modem.

## External

A distinction is made between internal and external calls when telephoning in a telecommunications system. External calls are calls to subscribers which are not connected to your telecommunications system. Connections between terminals of your telecommunications system and other terminals at your multi-equipment access are therefore also external connections. The local tariff is usually charged for such connections.

## External seizure (seize outside line)

Seizure of a line (B-channel) to call an external subscriber.

## Outgoing external connection

Connection to an external subscriber set up from a terminal of the telecommunications system by dialling an external phone number.

## Pulse dialling method (PD)

Every dialled digit is assigned a fixed number of pauses. The pauses are audible in the earphone when dialling.

## Internal

Internal calls are calls which subscribers in the telecommunication system hold with each other by dialling the internal phone number. These calls are generally free.

## ISDN (Integrated Services Digital Network)

All services (speech and data) can now be transmitted in one network.

## Incoming external connection

Connection to a terminal of the telecommunications system set up by an external subscriber with the phone number of the telecommunications system.

## Configuration

Setting (programming) the functions of the telecommunications system with a PC by means of a configuration program.

## Line (B-channel/S0 basic access)

You can connect an external S0 basic access to your ISDN telecommunications system. Every external S0 basic access behaves like two conventional analog lines. You therefore have two lines (B-channels) on which you can make telephone calls (local, long distance or overseas calls).

## Dual tone multi-frequency dialling method (DTMF)

Every dialled digit is assigned a certain tone. Telephones with this dialling method require a signal key (refer back key R) on the telecommunications system.

## MoH (Music on Hold)

A waiting external subscriber hears music whilst the connection is on hold, e.g. when a call is forwarded.

## MSN (Multiple Subscriber Number)

The multiple subscriber number is one of the phone numbers under which the multi-equipment access can be reached.

## NTBA (Network Termination for ISDN Basic Access)

The network operator lays his copper cables up to this access point (S0 basic access). You connect your telecommunications system and other ISDN terminals to it.

## Ringling assignment

In the ringling assignment you define which terminals of the telecommunications system are to ring when an external call is received. Should only one terminal ring or several terminals simultaneously?

Ringing assignments for external calls are: day service, night service and forwarding (internal). You can switch over between day and night service at any time from any telephone. Internal call forwarding – An incoming external call which is not answered within a certain time is forwarded. The terminals of the telecommunications system defined in the call forwarding then ring. The number of rings until forwarding is adjustable.

**Switch box**

You can call the switch box of your telecommunications system externally and for example switch the ringing assignment, set up a diversion or monitor a room with a post-dialled \* procedure.

You can reach the switch box externally by a multiple subscriber number (MSN) specially assigned to the switch box. The switch box is protected against unauthorised access by the box PIN.

**Signal key R (refer back)**

A key on the telephone which you have to press when you want to refer back to another subscriber during a call. The signal key must have the flash function, i.e. must be able to effect a short pause.

**USB**

**U**niversal **S**erial **B**us is a serial interface with transmission rate up to 12 Mbit/s. A USB connection can serve several items of equipment simultaneously. These can be added or removed during the current operation.

**If something goes wrong**

**Inspections**

- In the case of malfunctions in the telecommunications system, please check the system is being operated correctly as described in the operating instructions.
- Check that the connections of the terminals and the telecommunications system are correctly plugged in.

- If you cannot eliminate a fault, your dealer will be glad to help.

N. B.! You can only use the ISDN features of your AGFEO ISDN telecommunications system if your network operator provides these features.

**Switching off the special dialling tone**

You hear the special dialling tone when you lift your telephone's handset. You hear the special dialling tone when do not disturb, automatic dialling or a diversion are active.

You can deactivate all functions which initiate a special dialling tone with the \* procedure.



Lift handset



Special dialling tone (deactivate functions)



Acknowledgement tone



Replace handset

**Power failure**

You cannot dial internally or externally during a power failure.

- callbacks are deleted

When power supply is recovered:

- the telecommunications system works again with the previously configured program. All the settings made by the programming mode or the PC program are retained providing the programming mode was properly terminated.

- the connections parked in the telecommunications system are deleted
- the connection cost totals and connection data records are saved.

# Behaviour in the event of faults

<b>Fault</b>	<b>Possible causes</b>	<b>Remedy</b>
Programming of telecommunications system unclear		Reset the telecommunications system  Reset the telecommunications system to the as-delivered state and reprogram
No dialling tone on lifting the handset	Power failure	Check mains connection, fuses
	Defective terminal	Check terminal at another connection
	Defective installation	Check the terminals in the socket and on the telecommunications system
No internal calls are received	Do not disturb switched on (special dialling tone)	Switch off do not disturb
	Diversion to another telephone (internal/external) (special dialling tone)	Switch off diversion
No external calls are received	Wrong MSN entered	Enter right MSN, delete all if necessary
	MSN – internal subscriber assignment missing	Assign internal subscriber to the MSN (ringing assignment)
	Do not disturb switched on (special dialling tone)	Switch off do not disturb
	Diversion to another telephone (internal/external) (special dialling tone)	Switch off diversion
	ISDN call forwarding is active	Deactivate ISDN call forwarding
No outgoing external connection possible	No authorisation programmed	Check authorisation, access to ISDN network, assignment of barred numbers
	Cost limit reached	Inform system administrator
Transfer of external call (refer back) not possible	The refer back key $\Gamma$ on the telephone is set as an earth key	Set the telephone to DTMF (tone dialling) and the refer back key to flash
	Incorrect flash time	Set the flash time on the telephone or on the telecommunications system for the terminal connection concerned

## Resetting the telecommunications system

You can return the programming of the telecommunications system to a defined condition by resetting. This may be necessary when unclear settings are to be reset or the telecommunications system is to be re-programmed.

After the reset, the telecommunications system operates again with the previously configured program. All the settings made by the programming mode or the PC program are retained providing the programming mode was terminated properly.

### Attention! The following are deleted when the telecommunications system is reset:

- all existing internal and external connections
- remote configuration
- internal callbacks
- ISDN callback on busy
- Line reservations

**Hardware reset** – Pull the power pack from the socket of the 230 V mains and plug it back in.

**Software reset** – Run the following procedure

## Software reset

Start programming mode:      (system PIN) 

**PRO**



## Rings

### External call

All ringing rhythms for incoming external calls start with an initial ringing of 500 ms. This is followed by a 2 s pause. This is for technical reasons to transmit the caller's phone number (CLIP). It is then possible to distinguish calls under different phone numbers of the telecommunications system (see diagram).

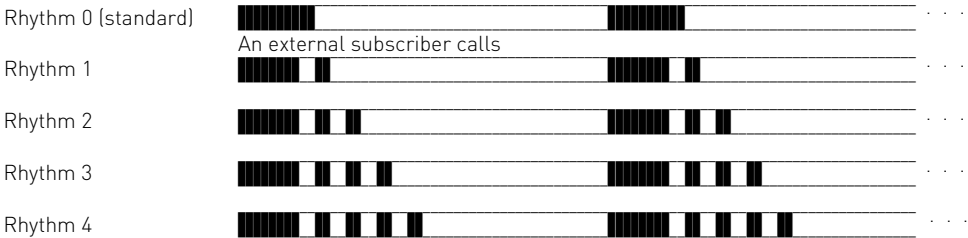

### Internal call

An internal subscriber calls

### Reserving a line



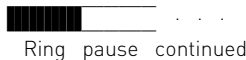

### Explanation:





The rings may deviate depending on the terminal used.

# Tones

## Dialling tone

- internal  signals that you can dial after lifting the handset
- external  continuous tone which you hear when you have seized a line after dialling "0"

## Ringing tone

- internal  The internal subscriber is called
- external  The external subscriber is called

## Busy tone

 The dialled internal or external subscriber is busy

## Special dialling tones

 Signals, after lifting the handset, that you can dial but do not disturb, automatic dialling or a diversion is switched on

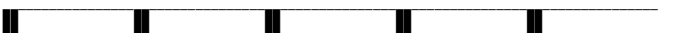
- Programming tone  Signals, after lifting the handset, that you cannot dial, the programming mode or the cost menu are switched on

- Lock tone  Signals, after lifting the handset, that the telephone is locked.

## Knocking tone

 Signals an external call in your conversation after 10 s

## Acknowledgement tone

 Input accepted

## Error tone

 Operating error/input rejected

## Explanation:

 tone pause continued

# Technical data

<b>Housing dimensions</b>	15.4 x 21.5 x 4.6 (width x height x depth) in cm
<b>Weight</b>	980 g including power pack
<b>Ambient temperature</b> - operation/storage	5 °C to 40 °C/-25 °C to +70 °C
<b>Humidity</b>	max. 70% (no condensation)
<b>Main connection</b> - power consumption at $U_{\text{rated}} = 230 \text{ V}$ and full load - length of the connecting cable - power pack (type)	230 VAC, +10%/-10%, 50 Hz  $I_{\text{rated}} = 40 \text{ mA}$ (9 VA) 2 m TST 433238
<b>S0 access</b> - connection  - length IAE cable	Multi-equipment access, Euro ISDN by Western socket RJ45 and enclosed IAE connecting cable IAE8/IAE8 1.5 m
<b>Analog terminals</b> - range - connection  - dialling method - refer back key - Modem operation	4 a/b terminals (telephone, answering machine, fax, modem 2 x 50 ohms ( $\varnothing$ 0.6 mm, 800 m) symmetrical, 2-wire via TASE connections without coding F or N or via screw terminals, plug-in Pulse dialling or DTMF Flash (50 to 200 ms) transmission speed up to 56600bps, can be reduced if necessary to 33600 bps by transmission path and lines
<b>PC interface</b> - range - connection - length of the PC cable	similar to RS 232C 3 m, +/-5 V 9-pole D-Sub socket 2m
<b>USB interface</b> - length of the USB cable	Universal Serial Bus 3 m
<b>Data backup during power failure</b>	unlimited
<b>Music on Hold (MoH)</b>	internal, 1 melodie

# Key words

## A

Acknowledgement tone	A - 5
Analog terminals	I - 4, S - 2
Answering calls	O - 3
Picking up a call	O - 11
Assigning the barred numbers	P - 8, P - 11
Asterisk key	I - 4, O - 3
Authorisation	O - 3
access to the ISDN network	P - 8
defining	P - 9

## B

B-channel. See Line	O - 6
Barred numbers	
assigning	P - 11
programming	P - 10
Barred range	O - 3
Basic factor	O - 25
Box PIN	O - 8, P - 17, A - 2
programming	P - 18
Brokerage	O - 16
Setting a variant	P - 14
Busy LED	I - 5, S - 1
Busy on busy	O - 7
Busy tone	A - 5

## C

Callback	O - 5, O - 16
internal	O - 17
on busy	O - 17
Calling an internal subscriber	O - 2
Calling external subscribers	O - 2
Callthrough one the move	O - 9
Charge pulses	O - 25
Clearing the memory	P - 4
CLIP function, set options	P - 16
Combi-device	P - 11
Combi-device connection	O - 2
Communication of the charge pulses	O - 25
Communication through PC	C - 1
Conference	O - 11
Connecting the PC	P - 1
Connecting the telecommunications system	S - 3
Connection assignment	S - 4
PC cable	P - 1
Connection costs	O - 1, O - 2, O - 25
Connection ID	O - 14
Connection panel	S - 1
opening and closing	S - 4
Connections to Internet or other network	C - 6
Cost menu	O - 25
Cost PIN	O - 25

CTI - Computer-assisted calling	C - 3
---------------------------------	-------

## D

Data transmission	I - 4
Day service	
programming	P - 5
switching on	O - 12
Defining ringing assignment	P - 5
Dialling method	I - 4, S - 2, A - 1
Dialling tone	A - 5
Direct call	O - 18
Display charges for the last call	O - 28
Diversion	O - 23
activating (switching on)	O - 24
deactivating (switching off)	O - 24
via the ISDN exchange	O - 23
via the telephone system	O - 23
Diversion from	O - 10
Do not disturb	O - 18
DT network	C - 6, A - 1
DTMF post-dialling	O - 3
Dual tone multi-frequency dialling method (DTMF)   - 4, A - 1	
Durchrufen von unterwegs	O - 9

## E

END (exit programming mode)	P - 4
Entering terminal types	P - 11
Entering the code	P - 18
Entering the limit	O - 26, P - 12
Error tone	A - 5
ESC (old settings)	P - 4
External	A - 1
External call	A - 4
External connection	
incoming	A - 1
outgoing	A - 1
External seizure	O - 2, A - 1
at combi-device connection	O - 2
spontaneous	O - 1
spontaneous with internal	O - 1
switching	O - 1
with "0"	O - 2
with certain MSN	O - 2

## F

Fallback	O - 12
Fault	A - 2
Fax	P - 11.
Follow me (diversion from)	O - 10
Forwarding (internal)	
Cycles (ringing cycles)	P - 7
Programming	P - 5

Free range P - 10  
Function LED I - 5, S - 1

## H

Hash key I - 4  
Having a caller identified O - 7

## I

Incoming external connection A - 1  
Input in the programming mode P - 3  
Inspections in the event of malfunctions A - 2  
Install driver software C - 4  
Installing the configuration program P - 1  
Interface  
    RS 232C S - 4  
Internal A - 1  
Internal call A - 4  
Internal phone numbers P - 5  
Internet C - 6  
ISDN A - 1  
    access (S0) S - 1, S - 2  
    bus S - 2  
    call forwarding O - 23  
    callback on busy O - 17  
    connecting cable S - 3  
    hold P - 14  
    malicious call tracing O - 7  
    parking (replugging on the bus) O - 13  
    sockets S - 2  
    terminals S - 2  
    transmitting the phone number O - 21

## K

Keys I - 5  
Knocking O - 3  
    answer call O - 3  
    reject O - 4  
Knocking prevention O - 4  
Knocking tone O - 3, A - 5  
KOS (start cost menu) O - 26

## L

Least Cost Routing (LCR) O - 12  
Light emitting diodes (LED) I - 5  
    Busy LED (red) I - 5  
    Function LED (green) I - 5  
Limit/Disconnect at limit O - 25  
Line O - 1, A - 1  
List of contents I - 3  
Loading new firmware P - 19  
Local network code P - 18  
Lock O - 18  
Locking/unlocking the telephone O - 18

## M

Malfunctions A - 2  
Malicious call tracing O - 7  
Minimum PC requirements P - 1  
Modem I - 4, P - 11  
MSN (Multiple Subscriber Number) A - 1  
Multi-equipment access S - 2  
Multiple subscriber numbers (MSN)  
    quick entry S - 3  
    save S - 3, P - 5  
Music on Hold (MoH) A - 1  
Muting O - 16

## N

Network code O - 12  
Network provider O - 12  
Night service O - 12  
    programming P - 15  
NTBA (NT) – network termination S - 2

## O

Outgoing external connection A - 1

## P

Parking  
    in the ISDN exchange O - 13  
    in the telephone system O - 13  
PC interface S - 1, S - 4  
Phonebook  
    Dialling the phone number O - 20  
    Programming the phone number O - 19  
Picking up a call O - 10  
Pictograms I - 5  
PIN (Personal Identity Number)  
    Box PIN O - 8  
    Cost PIN O - 25  
    System PIN P - 17  
    Telephone PIN O - 18  
Post dialling O - 3  
Post dialling numbers O - 3  
Power failure A - 2  
Power pack  
    connecting S - 3  
Power pack  
    connecting S - 2  
Power  
    connecting S - 3  
Power supply S - 2  
PRO (start programming mode) P - 3  
Program components of software C - 1  
Programming  
    with a PC P - 1  
    with a telephone P - 3  
Programming mode



exit	P - 4
start	P - 3
Programming regional numbers	P - 10
Programming short commands	P - 12
Pulse dialling method	I - 4, A - 1

## R

Refer back	O - 16
in the room	O - 16
Remote configuration – Remote service	
Release	P - 2
Remote service phone number	P - 2
Remote control (switch box)	O - 8
Reserving a line	O - 2, A - 4
Resetting the telecommunications system	A - 4
Restoring old settings	P - 4
Restoring the as-delivered state	P - 4
Ring assignment	O - 12, A - 1
Ring rhythms	A - 4
setting	P - 7
Ring tone	A - 5
Rings	A - 4
Room monitoring	O - 15
RS 232C interface	S - 4

## S

S0 basic access	A - 1
Safety Instructions	I - 4
Scope of delivery	S - 1
Selecting location	S - 1
Send zero	P - 15
Service ID	P - 11
Services	A - 1
Set up USB connection	C - 4
Setting external calls	P - 7
Setting list of callers	P - 13
Setting the call list	P - 13
Setting the flash time	P - 14
Short dialling index	O - 19
Signal key R (refer back)	I - 4, A - 2
Software overview	C - 1
Special dialling tone	O - 6, O - 10, O - 18, A - 5
ISDN exchange	O - 24
switching off	A - 2
Standard PIN	P - 17
Switch box	O - 8, P - 6, A - 2
Box PIN	P - 17, A - 2
Phone number	P - 6
System PIN	
entering	P - 3, P - 17
programming	P - 17
System requirements	C - 4

## T

TAPI interface	C - 3
Tariff unit	O - 25
Technical data	A - 6
Telephone	P - 11
Telephone line	S - 4
Telephone PIN	O - 18
Telephoning	
Calling externally	O - 2
Calling internally	O - 2
Terminals	A - 1
Analog	I - 4
Connecting to external TAE sockets	S - 4
Connecting to the telecommunications system	S - 2
Flash time	S - 2, P - 14
Types	S - 2, P - 11
Three-party conference	O - 11
Timer	O - 21
TK-Suite	C - 1
Tones	A - 5
Tracing – identifying malicious callers	O - 7
Transferring a call	O - 5
Internal	O - 5
Transmitting the phone number	O - 1, O - 2
Switching	O - 21
Transmitting your phone number	O - 1, O - 2, O - 21
TSP	C - 3

## U

USB connection	C - 4
USB-interface	S - 4
User factor	O - 25

## W

Wall mounting	S - 3
Western plug	S - 3

---

## Copyright

Copyright 2004 AGFEO GmbH & Co. KG  
Gaswerkstr. 8  
D-33647 Bielefeld

We reserve all rights to this documentation; this applies especially in the event of a patent award or registered utility.

The documentation may not be changed or translated manually or in any other way into any

language or computer language of any form by any means neither wholly nor in part without our express permission. This applies for electronic, mechanical, optical, chemical and all other media.

Trade marks and names used in this documentation are subject to the rights of the companies concerned.

---

## Technical modifications

The AGFEO GmbH & Co. KG reserves the right to change representations and data in this documentation in the interests of technical progress without prior notice.

This documentation has been prepared with the utmost care and is revised regularly. Despite all our care, however, technical inaccuracies and typographical errors cannot be totally ruled out. All errors which become known to us will be corrected in new editions. We are grateful for any hints at errors in this documentation.

You can only use the numerous ISDN features of your AGFEO ISDN telecommunications system if your network operator offers them.

## Konformitätserklärung

Declaration of Conformity  
Déclaration de Conformité

Der Hersteller: AGFEO GMBH & Co. KG  
The Manufacturer:  
Le Constructeur:

Adresse: Gaswerk Str. 8  
Address: D - 33647 Bielefeld  
Adresse:

Erklärt, dass das Produkt: AC 14 WebPhonie  
Declares that the Product:  
Déclare que le Produit::

die grundlegenden Anforderungen gemäß Artikel 3 der nachstehenden EU-Richtlinien erfüllt:  
meets the essential requirements according to article 3 of the following EC-Directive:  
est conforme aux exigences essentielles d' article 3 de la Directive CE:

Richtlinie 1999/5/EG des Europäischen Parlaments und des Rates vom 09. März 1999  
über Funkanlagen und Telekommunikationsendeinrichtungen und die gegenseitige  
Anerkennung ihrer Konformität

Directive 1999/5/EC of the European Parliament and of the Council of 09 March 1999 relating to  
radio and telecommunications terminal equipment, including the mutual recognition of their  
conformity  
Directive 1999/5/CE du Parlement européen et du Conseil du 09 mars 1999 concernant les radio  
et équipement terminaux de télécommunications, incluant la reconnaissance mutuelle de leur  
conformité

und dass die folgenden harmonisierten Normen angewandt wurden:  
and that the following harmonised standards has been applied:  
et que les standards harmonisés suivants ont été appliqués:

EN 60950/1997  
EN 55022/1998  
EN 55024/1998  
TBR3 Anhang 1/Dez. 1997  
Schicht 1-3

Bielefeld, 07. September 2000

Ort und Datum der Konformitätserklärung  
Place and date of the declaration  
Lieu et date de la déclaration

-----  
  
Name und Unterschrift der Geschäftsleitung  
Name and Signature  
Nom et Signature

K



This device meets the requirements of the EU directives:  
91/263/EWG            Telecommunications Equipment  
73/23/EWG             Low voltage equipment  
89/336/EWG            Electromagnetic compatibility  
Your telephone carries the CE mark of approval.

Ident. No. 1538477  
Subject to modifications.  
Printed in Germany  
0047

**AGFEO** GmbH & Co. KG  
Gaswerkstr. 8  
D-33647 Bielefeld  
Internet: <http://www.agfeo.de>